

AV Receiver

DTR-7.8

Instruction Manual

Integra

Thank you for purchasing an Integra AV Receiver. Please read this manual thoroughly before making connections and plugging in the unit. Following the instructions in this manual will enable you to obtain optimum performance and listening enjoyment from your new AV Receiver. Please retain this manual for future reference.

WARNING:

TO REDUCE THE RISK OF FIRE OR ELECTRIC SHOCK, DO NOT EXPOSE THIS APPARATUS TO RAIN OR MOISTURE.

CAUTION:

TO REDUCE THE RISK OF ELECTRIC SHOCK, DO NOT REMOVE COVER (OR BACK). NO USER-SERVICEABLE PARTS INSIDE. REFER SERVICING TO QUALIFIED SERVICE PERSONNEL.



WARNING
RISK OF ELECTRIC SHOCK
DO NOT OPEN

AVIS
RISQUE DE CHOC ELECTRIQUE
NE PAS OUVRI



The lightning flash with arrowhead symbol, within an equilateral triangle, is intended to alert the user to the presence of uninsulated "dangerous voltage" within the product's enclosure that may be of sufficient magnitude to constitute a risk of electric shock to persons.



The exclamation point within an equilateral triangle is intended to alert the user to the presence of important operating and maintenance (servicing) instructions in the literature accompanying the appliance.

Important Safety Instructions

1. Read these instructions.
2. Keep these instructions.
3. Heed all warnings.
4. Follow all instructions.
5. Do not use this apparatus near water.
6. Clean only with dry cloth.
7. Do not block any ventilation openings. Install in accordance with the manufacturer's instructions.
8. Do not install near any heat sources such as radiators, heat registers, stoves, or other apparatus (including amplifiers) that produce heat.
9. Do not defeat the safety purpose of the polarized or grounding-type plug. A polarized plug has two blades with one wider than the other. A grounding type plug has two blades and a third grounding prong. The wide blade or the third prong are provided for your safety. If the provided plug does not fit into your outlet, consult an electrician for replacement of the obsolete outlet.
10. Protect the power cord from being walked on or pinched particularly at plugs, convenience receptacles, and the point where they exit from the apparatus.
11. Only use attachments/accessories specified by the manufacturer.
12. Use only with the cart, stand, tripod, bracket, or table specified by the manufacturer, or sold with the apparatus. When a cart is used, use caution when moving the cart/apparatus combination to avoid injury from tip-over.
13. Unplug this apparatus during lightning storms or when unused for long periods of time.
14. Refer all servicing to qualified service personnel. Servicing is required when the apparatus has been damaged in any way, such as power-supply cord or plug is damaged, liquid has been spilled or objects have fallen into the apparatus, the apparatus has been exposed to rain or moisture, does not operate normally, or has been dropped.
15. Damage Requiring Service
 - Unplug the apparatus from the wall outlet and refer servicing to qualified service personnel under the following conditions:
 - A. When the power-supply cord or plug is damaged,
 - B. If liquid has been spilled, or objects have fallen into the apparatus,
 - C. If the apparatus has been exposed to rain or water,
 - D. If the apparatus does not operate normally by following the operating instructions. Adjust only those controls that are covered by the operating instructions as an improper adjustment of other controls may result in damage and will often require extensive work by a qualified technician to restore the apparatus to its normal operation,
 - E. If the apparatus has been dropped or damaged in any way, and
 - F. When the apparatus exhibits a distinct change in performance this indicates a need for service.
16. Object and Liquid Entry

Never push objects of any kind into the apparatus through openings as they may touch dangerous voltage points or short-out parts that could result in a fire or electric shock.

The apparatus shall not be exposed to dripping or splashing and no objects filled with liquids, such as vases shall be placed on the apparatus.

Don't put candles or other burning objects on top of this unit.
17. Batteries

Always consider the environmental issues and follow local regulations when disposing of batteries.
18. If you install the apparatus in a built-in installation, such as a bookcase or rack, ensure that there is adequate ventilation.

Leave 20 cm (8") of free space at the top and sides and 10 cm (4") at the rear. The rear edge of the shelf or board above the apparatus shall be set 10 cm (4") away from the rear panel or wall, creating a flue-like gap for warm air to escape.

PORTABLE CART WARNING



S3125A

Precautions

1. **Recording Copyright**—Unless it's for personal use only, recording copyrighted material is illegal without the permission of the copyright holder.
2. **AC Fuse**—The AC fuse inside the unit is not user-serviceable. If you cannot turn on the unit, contact the dealer from whom you purchased this unit..
3. **Care**—Occasionally you should dust the unit all over with a soft cloth. For stubborn stains, use a soft cloth dampened with a weak solution of mild detergent and water. Dry the unit immediately afterwards with a clean cloth. Don't use abrasive cloths, thinners, alcohol, or other chemical solvents, because they may damage the finish or remove the panel lettering.

4. Power

WARNING

BEFORE PLUGGING IN THE UNIT FOR THE FIRST TIME, READ THE FOLLOWING SECTION CAREFULLY.

AC outlet voltages vary from country to country. Make sure that the voltage in your area meets the voltage requirements printed on the unit's rear panel (e.g., AC 230 V, 50 Hz or AC 120 V, 60 Hz).

The power cord plug is used to disconnect this unit from the AC power source. Make sure that the plug is readily operable (easily accessible) at all times.

For North American model

Pressing the [Standby/On] button to select Standby mode does not fully shutdown the unit. If you do not intend to use the unit for an extended period, remove the power cord from the AC outlet.

5. **Never Touch this Unit with Wet Hands**—Never handle this unit or its power cord while your hands are wet or damp. If water or any other liquid gets inside this unit, have it checked by the dealer from whom you purchased this unit.
6. **Handling Notes**
 - If you need to transport this unit, use the original packaging to pack it how it was when you originally bought it.
 - Do not leave rubber or plastic items on this unit for a long time, because they may leave marks on the case.
 - This unit's top and rear panels may get warm after prolonged use. This is normal.
 - If you do not use this unit for a long time, it may not work properly the next time you turn it on, so be sure to use it occasionally.

For U.S. models

FCC Information for User

CAUTION:

The user changes or modifications not expressly approved by the party responsible for compliance could void the user's authority to operate the equipment.

NOTE:

This equipment has been tested and found to comply with the limits for a Class B digital device, pursuant to Part 15 of the FCC Rules. These limits are designed to provide reasonable protection against harmful interference in a residential installation.

This equipment generates, uses and can radiate radio frequency energy and, if not installed and used in accordance with the instructions, may cause harmful interference to radio communications. However, there is no guarantee that interference will not occur in a particular installation. If this equipment does cause harmful interference to radio or television reception, which can be determined by turning the equipment off and on, the user is encouraged to try to correct the interference by one or more of the following measures:

- Reorient or relocate the receiving antenna.
- Increase the separation between the equipment and receiver.
- Connect the equipment into an outlet on a circuit different from that to which the receiver is connected.
- Consult the dealer or an experienced radio/TV technician for help.

For Canadian Models

NOTE: THIS CLASS B DIGITAL APPARATUS COMPLIES WITH CANADIAN ICES-003.

For models having a power cord with a polarized plug:

CAUTION: TO PREVENT ELECTRIC SHOCK, MATCH WIDE BLADE OF PLUG TO WIDE SLOT, FULLY INSERT.

Modèle canadien

REMARQUE: CET APPAREIL NUMÉRIQUE DE LA CLASSE B EST CONFORME À LA NORME NMB-003 DU CANADA.

Sur les modèles dont la fiche est polarisée:

ATTENTION: POUR ÉVITER LES CHOCS ÉLECTRIQUES, INTRODUIRE LA LAME LA PLUS LARGE DE LA FICHE DANS LA BORNE CORRESPONDANTE DE LA PRISE ET POUSSER JUSQU'AU FOND.

Precautions—Continued

For British models

Replacement and mounting of an AC plug on the power supply cord of this unit should be performed only by qualified service personnel.

IMPORTANT

The wires in the mains lead are coloured in accordance with the following code:

Blue: Neutral

Brown: Live

As the colours of the wires in the mains lead of this apparatus may not correspond with the coloured markings identifying the terminals in your plug, proceed as follows:



The wire which is coloured blue must be connected to the terminal which is marked with the letter N or coloured black.

The wire which is coloured brown must be connected to the terminal which is marked with the letter L or coloured red.

IMPORTANT

The plug is fitted with an appropriate fuse. If the fuse needs to be replaced, the replacement fuse must be approved by ASTA or BSI to BS1362 and have the same ampere rating as that indicated on the plug. Check for the ASTA mark or the BSI mark on the body of the fuse. If the power cord's plug is not suitable for your socket outlets, cut it off and fit a suitable plug. Fit a suitable fuse in the plug.

For European Models

Declaration of Conformity	
We, ONKYO EUROPE ELECTRONICS GmbH LIEGNITZERSTRASSE 6, 82194 GROEBENZELL, GERMANY	
declare in own responsibility, that the ONKYO product described in this instruction manual is in compliance with the corresponding technical standards such as EN60065, EN55013, EN55020 and EN61000-3-2, -3-3.	
GROEBENZELL, GERMANY	 K. MIYAGI
ONKYO EUROPE ELECTRONICS GmbH	

Contents

Features	6	Playing Your AV Components	60
Supplied Accessories	7	Basic AV Receiver Operation	60
Multiroom Capability	8	Listening to the Radio	61
Getting to Know the AV Receiver	9	Listening to AM/FM Stations	61
Front Panel	9	Using RDS (not North American model)	63
Display	11	Listening to XM Satellite Radio® (North American Model Only)	65
Rear Panel	12	Listening to SIRIUS Satellite Radio® (North American Models Only)	70
Remote Controller	14	Presetting AM, FM, XM, and SIRIUS Stations	78
Installing the Batteries	14	Common Functions	79
Using the Remote Controller	14	Setting the Display Brightness	79
About the Remote Controller Modes	15	Adjusting Speaker Levels	79
Receiver/Tape Mode	15	Muting the AV Receiver	79
DVD Mode	17	Using the Sleep Timer	80
CD/MD/CDR Modes	18	Using Headphones	80
Dock Mode	19	Displaying Source Information	80
Connecting Your Speakers	20	Selecting Audio Inputs	81
Enjoying Home Theater	20	Specifying the Digital Signal Format	81
Connecting Your Speakers	21	Using the Listening Modes	82
Bi-amping the Front Speakers	23	Selecting the Listening Modes	82
Connecting Antennas	24	Listening Modes Available for Each Source Format	83
Connecting the Indoor FM Antenna	24	About the Listening Modes	87
Connecting the AM Loop Antenna	24	Recording	89
Connecting an Outdoor FM Antenna	25	Recording the Input Source	89
Connecting an Outdoor AM Antenna	25	Recording from Different AV Sources	89
Connecting Your Components	26	Onscreen Setup Menus	90
About AV Connections	26	Menu Map	90
Connecting Audio and Video Signals to the AV Receiver	27	Adjusting the Listening Modes	91
Which Connections Should I Use?	27	Using the Re-EQ Function	91
Connecting a TV or Projector	29	Using the Late Night Function	91
Connecting a DVD player	30	Audio Adjust	92
Connecting a VCR or DVR for Playback	32	Listening Mode Presets	94
Connecting a VCR or DVR for Recording	33	Advanced Setup	96
Connecting a Satellite, Cable, or Terrestrial Set-top box or Other Video Source	34	Speaker Setup	96
Connecting Components with HDMI	35	Source Setup	103
Connecting a Game Console	37	Miscellaneous Setup	106
Connecting a Camcorder or Other AV Component	38	Hardware Setup	108
Connecting a CD Player	39	Lock Setup	110
Connecting a Turntable	39	Zone 2 and Zone 3	111
Connecting a Cassette, CDR, MiniDisc, or DAT Recorder	40	Connecting Zone 2	111
Connecting a Power Amplifier	40	Connecting Zone 3	112
Connecting an RI Dock	41	Powered Zone 2 Setting	113
Connecting the Power Cords of Other Components (North American model only)	41	Zone 2/Zone 3 Out Settings	114
Connecting Integra/Onkyo RI Components	42	Using Zone 2 and Zone 3	114
Connecting the Power Cord	42	Using the 12V Triggers	117
Turning On the AV Receiver	43	Using the Remote Controller in Zone 2/3 and Multiroom Control Kits	118
Turning On and Standby	43	Controlling Other Components	119
First Time Setup	44	Entering Remote Control Codes	119
Speaker Settings	44	Resetting the Remote Controller	120
HDMI Monitor Setup	45	Learning Commands	122
HDMI Input Setup	46	Using Macros	123
Component Video Input Setup	48	Troubleshooting	124
Changing the Input Display	49	Specifications	127
Digital Input Setup	50		
Analog Input Setup	52		
Automatic Speaker Setup (Audyssey MultEQ XT)	53		
TV Format Setup (not North American models)	58		
AM Frequency Step Setup (on some models)	59		

Features

Amplifier

- 7-channel amplifier
- 130 watts minimum continuous power per channel, 8 ohm loads, 2 channels driven from 20 Hz to 20 kHz, with a maximum total harmonic distortion of 0.08% (FTC)
- Linear Optimum Gain Volume Circuitry
- Powered Zone 2 capability
- Bi-amp capability for front speakers
- WRAT (Wide Range Amplifier Technology)
- Massive High Current Power Supply (H.C.P.S.) transformer
- Color-coded speaker terminal posts

Processing

- THX^{*1} Surround EX
- THX Ultra2^{*1} certified
- Dolby^{*2} Digital, Dolby Digital EX, Dolby Digital Plus, Dolby TrueHD, Dolby Pro Logic IIx
- DTS^{*3}, DTS-ES Discrete, DTS-ES Matrix, DTS-HD Master Audio, DTS-HD High Resolution, DTS 96/24, DTS Neo:6
- Neural Surround^{*4}, THX-Neural
- Theater-Dimensional^{*5} virtual surround sound
- DSD Direct
- 192 kHz/24-bit D/A converters
- Powerful and highly accurate 32-bit DSP processing
- Re-EQ^{*6} function
- Tone control on all channels (7.1)
- 15-band EQ on 7 channels, 5-band EQ on subwoofer

Audio/Video

- Zone 2 with level, tone, balance, and left, right, and subwoofer pre outs, and composite video output, and component video output (assignable).
- Zone 3 with level, balance, and left, right, and subwoofer pre outs
- 3 HDMI^{*7} inputs, 1 output (Version 1.3a)
- HDMI upconversion of composite video, S-Video, and component video sources
- Component video upconversion of composite video and S-Video sources
- Composite video to S-Video and S-Video to composite video conversion
- 6 digital inputs (3 optical, 3 coaxial), 1 output (optical)
- 3 component video inputs, 2 outputs
- 6 S-Video inputs, 2 outputs
- RS-232 control
- Color-coded, assignable 7.1 multichannel input
- 7.1-channel pre out

Tuner

- XM^{*8} Satellite Radio ready (N. America only)
* XM Mini-Tuner and Home Dock required; sold separately.
- SIRIUS^{*9} Satellite Radio ready (N. America only)
* SiriusConnect Home tuner kit required; sold separately.
- 40 AM/FM/SIRIUS/XM presets (N. American model)
- 40 AM/FM presets (other models)
- AM/FM auto tuning
- RDS radio data (Australia only)
- Direct tuning

Others

- Audyssey MultEQ XT room correction^{*10}
- Easy-to-use onscreen setup menus
- IR IN A/B and OUT
- 12V TRIGGER OUT A, B, C
- Preprogrammed remote controller for use with other AV components, with Learning and Macro functions



THX and Ultra2 are trademarks of THX Ltd. THX may be registered in some jurisdictions. All rights reserved. Surround EX is a trademark of Dolby Laboratories. Used with permission.



Manufactured under license from Dolby Laboratories. "Dolby", "Pro Logic" and the double-D symbol are trademarks of Dolby Laboratories.



"DTS" is a registered trademark of DTS, Inc., and "DTS-HD Master Audio" is a trademark of DTS, Inc.



Neural Surround is a trademark owned by Neural Audio Corporation, THX is a trademark of THX Ltd., which may be registered in some jurisdictions. All rights reserved.



Theater-Dimensional is a trademark of Onkyo Corporation.

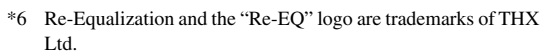

Re-Equalization and the "Re-EQ" logo are trademarks of THX Ltd.



HDMI, the HDMI logo and High Definition Multimedia Interface are trademarks or registered trademarks of HDMI Licensing, LLC.



XM Ready[®] is a trademark of XM Satellite Radio Inc. ©2005 XM Satellite Radio Inc. All rights reserved.

Features—Continued

*9 **SIRIUS** R E A D Y

©2005 SIRIUS Satellite Radio Inc. “SIRIUS,” SiriusConnect, the SIRIUS dog logo, channel names and logos are trademarks of SIRIUS Satellite Radio Inc. Available only in the contiguous United States (excluding Alaska and Hawaii) and Canada.

*10 **AUDYSSEY** MULTEQ XT

Manufactured under license from Audyssey Laboratories. U.S. and foreign patents pending. Audyssey MultEQ XT is a trademark of Audyssey Laboratories.

THX Ultra2

Before any home theater component can be THX Ultra2 certified, it must pass a rigorous series of quality and performance tests. Only then can a product feature the THX Ultra2 logo, which is your guarantee that the Home Theater products you purchase will give you superb performance for many years to come. THX Ultra2 requirements define hundreds of parameters, including power amplifier performance, and pre-amplifier performance and operation for both digital and analog domains. THX Ultra2 receivers also feature proprietary THX technologies (e.g., THX Mode) which accurately translate movie soundtracks for home theater playback.

- * “Xantech” is a registered trademark of Xantech Corporation.
- * “Niles” is a registered trademark of Niles Audio Corporation.
- * Apple and iPod are trademarks of Apple Computer, Inc., registered in the U.S. and other countries.

This product incorporates copyright protection technology that is protected by U.S. patents and other intellectual property rights. Use of this copyright protection technology must be authorized by Macrovision Corporation, and is intended for home and other limited consumer uses only unless otherwise authorized by Macrovision. Reverse engineering or disassembly is prohibited.

Supplied Accessories

Make sure you have the following accessories:

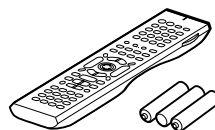

Remote controller and three batteries (AA/R6)

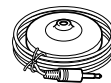

Speaker setup microphone



Indoor FM antenna

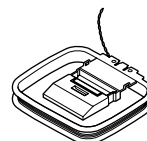

AM loop antenna

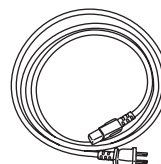

Power cord
(Power cord varies from country to country.)

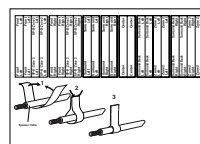

Speaker cable labels

- * In catalogs and on packaging, the letter at the end of the product name indicates the color. Specifications and operation are the same regardless of color.

Multiroom Capability

You can use three speaker systems with this AV receiver—a surround-sound speaker system (up to 7.1 channels) in your main listening room, a stereo speaker system in a second room, or Zone 2, as we call it, and another stereo speaker system in a third room that we call Zone 3 (external power amplifier required). And, you can select a different audio source for each room.

Main Room: In your main listening room, you can enjoy up to 7.1-channel playback (see pages 21–22). You can enjoy the various listening modes such as Dolby, DTS, and THX (pages 82–88).

*While Powered Zone 2 is being used, playback is reduced to 5.1-channels (see page 111).

Zone 2: In your Zone 2 room, you can enjoy 2-channel stereo playback (see page 111).

Zone 3: In your Zone 3 room, you can enjoy 2-channel stereo playback (see page 112).

*The listening modes cannot be used with Zone 2 and Zone 3.

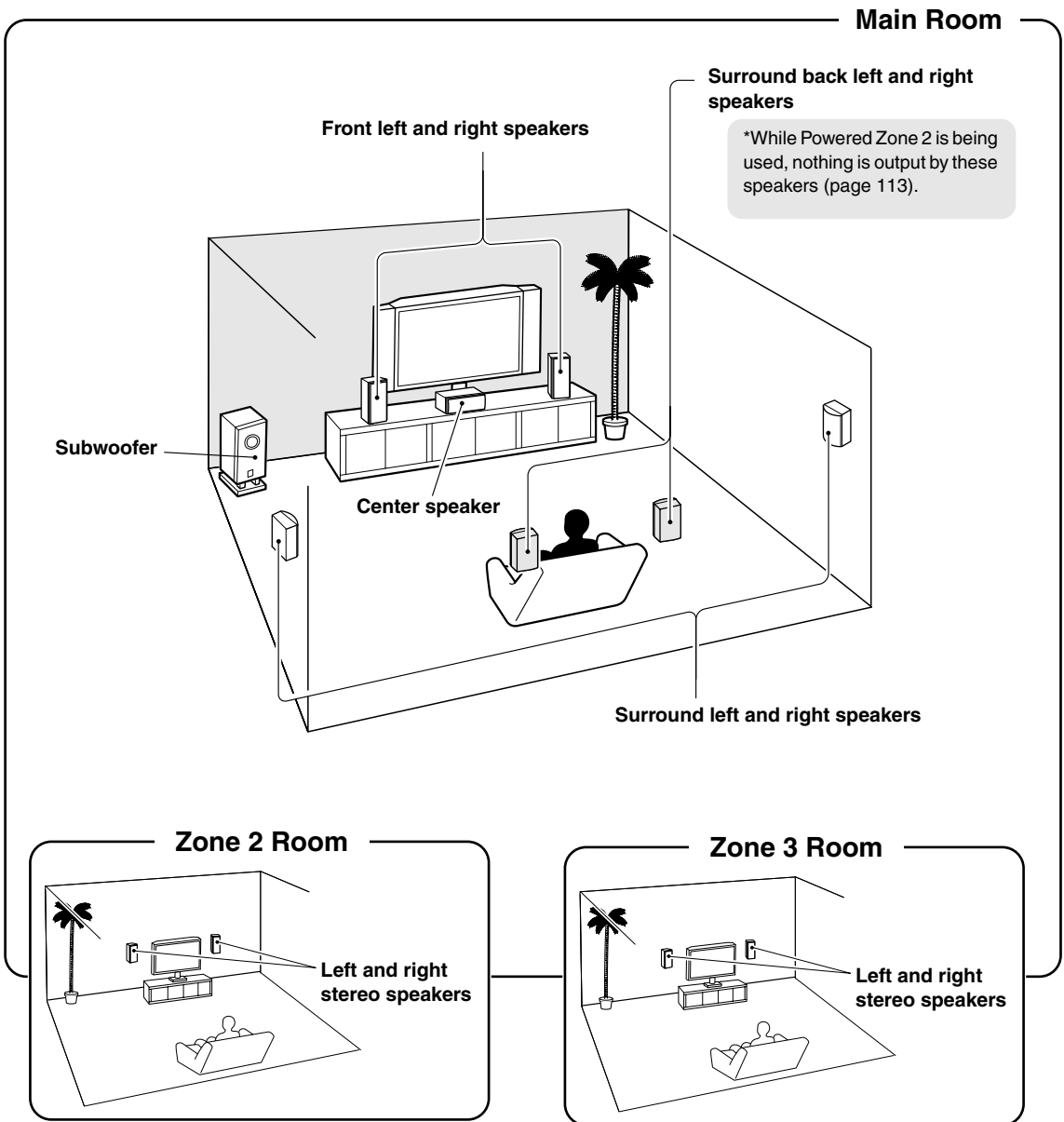

Getting to Know the AV Receiver

Front Panel

North American model

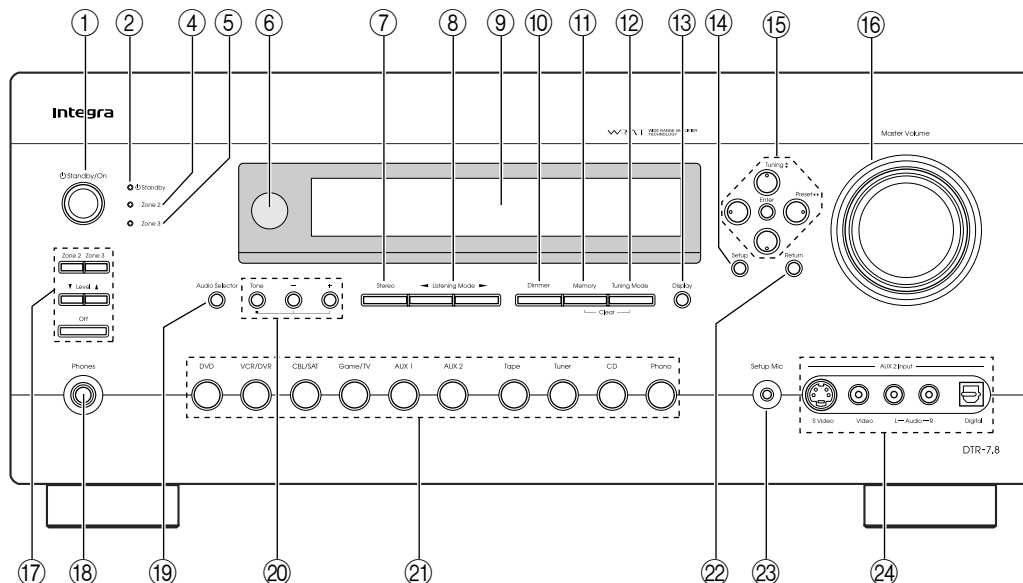

Other models

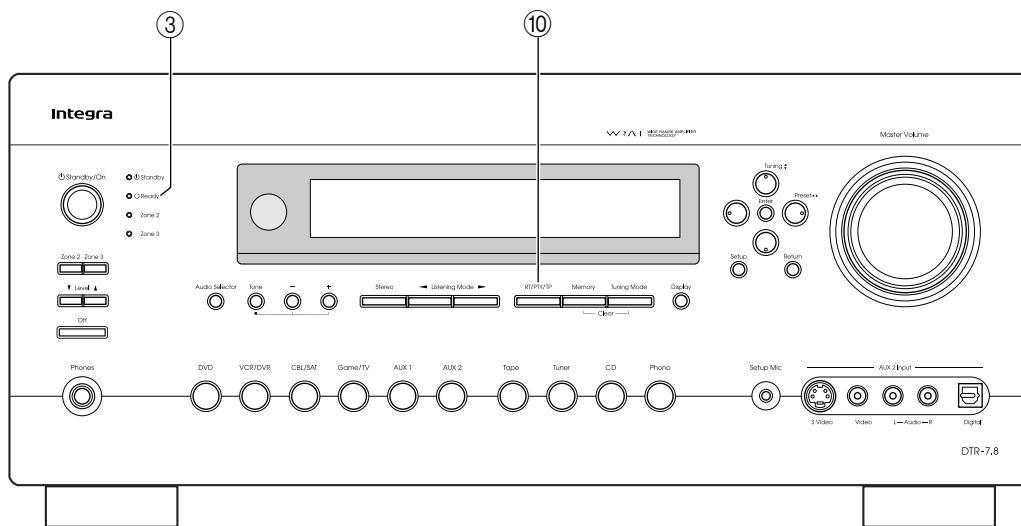

The actual front panel has various logos printed on it. They are not shown here for clarity.

For detailed information, see the pages in parentheses.

- ① **Standby/On button (43)**
Sets the AV receiver to On or Standby.
- ② **Standby indicator (43)**
Lights up when the AV receiver is on Standby and flashes while a signal is being received from the remote controller.
- ③ **Ready indicator (109)**
North American model doesn't have this indicator. Lights up when the AV receiver is on Standby and HDMI Power Control is enabled.
- ④ **Zone 2 indicator (115)**
Flashes when Zone 2 is being set. Lights up when Zone 2 is on.

- ⑤ **Zone 3 indicator (115)**
Flashes when Zone 3 is being set. Lights up when Zone 3 is on.
- ⑥ **Remote-control sensor (14)**
Receives control signals from the remote controller.
- ⑦ **Stereo button (82)**
Selects the Stereo listening mode.
- ⑧ **Listening Mode [◀]/[▶] buttons (82)**
Select the listening modes.
- ⑨ **Display**
See “Display” on page 11.
- ⑩ **Dimmer (RT/PTY/TP) button (64, 79)**
Adjusts the display brightness.

On models other than the North American model, this is the RT/PTY/TP button, and it’s used with RDS (Radio Data System). See “Using RDS (not North American model)” on page 63.
- ⑪ **Memory button (78)**
Used when storing or deleting radio presets.
- ⑫ **Tuning Mode button (61)**
Selects the Auto or Manual tuning mode for AM and FM radio.
- ⑬ **Display button (80)**
Displays various information about the currently selected input source.
- ⑭ **Setup button**
Opens and closes the onscreen setup menus, which are displayed on the connected TV.
- ⑮ **Tuning, Preset, Arrow, and Enter buttons**
When AM or FM is selected, the Tuning [▲] [▼] buttons are used for radio tuning, and the Preset [◀] [▶] buttons are used to select radio presets (see page 78). With the onscreen setup menus, they work as arrow buttons and are used to select and set items. The Enter button is also used with the onscreen setup menus.
- ⑯ **Master Volume control (60)**
Sets the volume of the AV receiver to $-\infty$ dB, -81.5 dB, -81.0 dB through $+18.0$ dB (relative display).

The volume level can also be displayed as an absolute value. See “Volume Setup” on page 106.
- ⑰ **Zone 2, Zone 3, Level [▲]/[▼], and Off buttons (115, 116)**
The Zone 2 button is used when setting Zone 2.
The Zone 3 button is used when setting Zone 3.

The Level Up and Down [▲]/[▼] buttons are used when adjusting the volume level of Zone 2 or Zone 3.

The Off button is used to turn off Zone 2 or Zone 3.
- ⑱ **Phones jack (80)**
This 1/4-inch phone jack is for connecting a standard pair of stereo headphones for private listening.
- ⑲ **Audio Selector button (81)**
Selects the audio input: analog, digital, HDMI, or multichannel.
- ⑳ **Tone, Plus [+], and Minus [-] buttons (92, 116)**
Used to adjust the tone (bass and treble), and the volume and balance of Zone 2 and Zone 3.
- ㉑ **Input selector buttons (60)**
Select the following input sources: DVD, VCR/DVR, CBL/SAT, Game/TV, AUX 1, AUX 2, Tape, Tuner, CD, Phono.
- ㉒ **Return button**
Selects the previously displayed onscreen setup menu.
- ㉓ **Setup Mic (53)**
The automatic speaker setup microphone connects here.
- ㉔ **AUX 2 Input (38, 89)**
Used to connect a camcorder, game console, and so on. There are input jacks for optical digital audio, S-Video, composite video, and analog audio.

Display

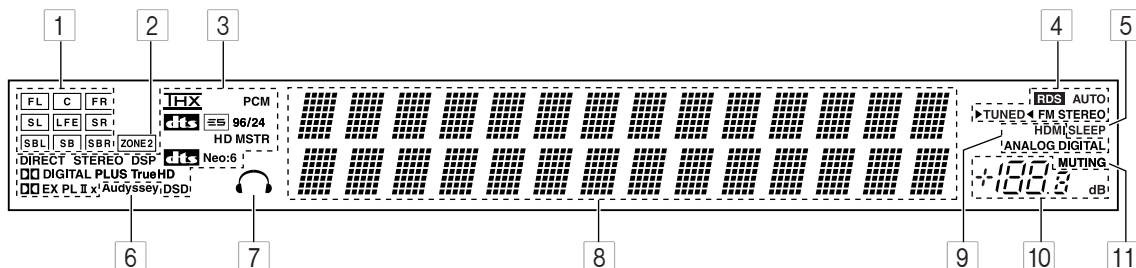

For detailed information, see the pages in parentheses.

1 Speaker/channel indicators (87)

Indicate the speaker configuration and channels used by the current input source.

- : A box is displayed for each speaker that's set in the Speaker Configuration. No box appears for speakers that are set to No or None.

The following abbreviations indicate which audio channels are included in the current input signal.

- **FL**: Front left
- **C**: Center
- **FR**: Front right
- **SL**: Surround left
- **LFE**: Subwoofer (Low Frequency Effects)
- **SR**: Surround right
- **SBL**: Surround back left
- **SB**: Surround back
- **SBR**: Surround back right

2 ZONE 2 indicator (115)

Lights up when Powered Zone 2 is being used.

3 Listening mode and format indicators (82)

Show the selected listening mode and audio input signal format.

4 Tuning indicators (61)

RDS (not North American model) (63):

Lights up when tuned to a radio station that supports RDS (Radio Data System).

AUTO (61): Lights up when Auto Tuning mode is selected for AM or FM radio. Goes off when Manual Tuning mode is selected.

TUNED (61): Lights up when tuned to a radio station.

FM STEREO (61): Lights up when tuned to a stereo FM station.

5 SLEEP indicator (80)

Lights up when the Sleep function has been set.

6 Audyssey indicator (53)

Lights up during automatic speaker setup.

7 Headphone indicator (80)

Lights up when a pair of headphones are plugged into the PHONES jack.

8 Message area

Displays various information.

9 Audio input indicators (81)

Indicate the type of audio input that's selected as the audio source: HDMI, ANALOG, or DIGITAL.

10 Volume level (60)

Displays the volume level.

11 MUTING indicator (79)

Flashes while the AV receiver is muted.

Rear Panel

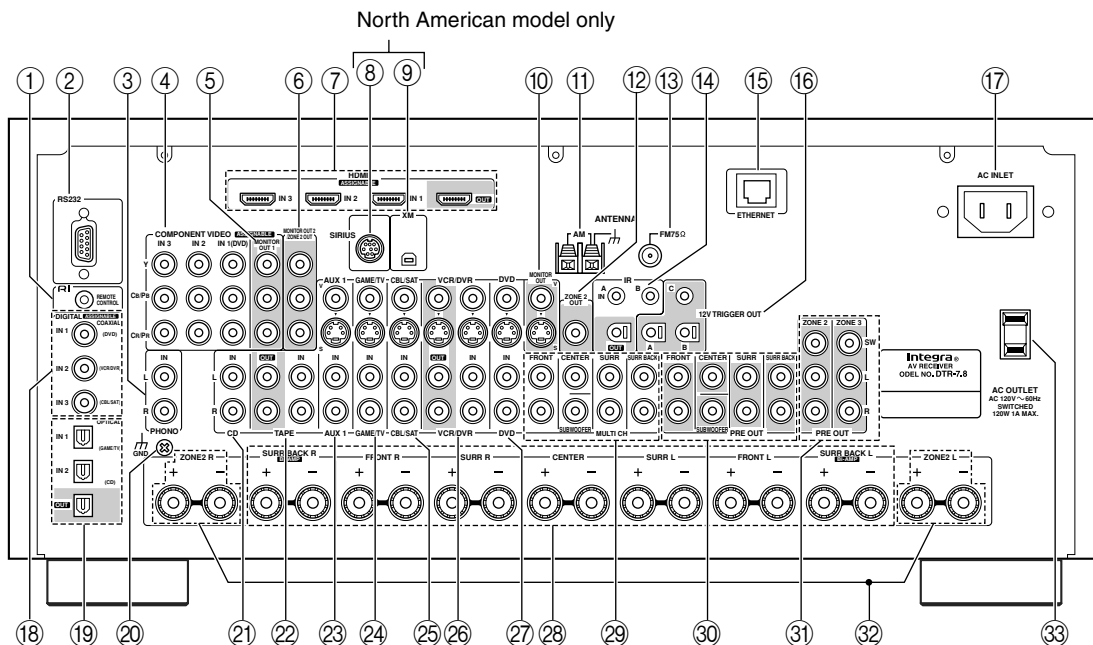

① **RI REMOTE CONTROL**

This **RI** (Remote Interactive) jack can be connected to the **RI** jack on another **RI**-capable Integra/Onkyo component for remote and system control.

To use **RI**, you must make an analog audio connection (RCA) between the AV receiver and the other component, even if they are connected digitally.

② **RS232**

This port is for connecting the AV receiver to home automation equipment and external controllers.

③ **PHONO IN**

This audio input is for connecting a turntable.

④ **COMPONENT VIDEO IN 1, 2, and 3**

These RCA component video inputs are for connecting components with a component video output, such as a DVD player, DVD recorder, or DVR (digital video recorder). They're assignable, which means you can assign each one to an input selector to suit your setup. See "Component Video Input Setup" on page 48.

⑤ **COMPONENT VIDEO MONITOR OUT 1**

This RCA component video output is for connecting a TV or projector with a component video input.

⑥ **COMPONENT VIDEO MONITOR OUT 2/ ZONE 2 OUT**

This RCA component video output is for connecting a TV or projector with a component video input located in your main listening room or Zone 2.

⑦ **HDMI IN 1–3 and OUT**

HDMI (High Definition Multimedia Interface) connections carry digital audio and digital video.

The HDMI inputs are for connecting components with an HDMI output, such as a DVD player, DVD recorder, or DVR (digital video recorder). They're assignable, which means you can assign each one to an input selector to suit your setup. See "HDMI Input Setup" on page 46.

The HDMI output is for connecting a TV or projector with an HDMI input.

⑧ **SIRIUS antenna (on North American model)**

This jack is for connecting a SIRIUS digital antenna, sold separately (see page 70).

⑨ **XM antenna (on North American model)**

This jack is for connecting an XM Mini-Tuner and Home Dock, sold separately (see page 65).

⑩ **MONITOR OUT**

The S-Video or composite video jack should be connected to a video input on your TV or projector.

⑪ **AM ANTENNA**

These push terminals are for connecting an AM antenna.

⑫ **ZONE 2 OUT**

This composite video output can be connected to a video input on a TV in Zone 2.

⑬ **FM ANTENNA**

This jack is for connecting an FM antenna.

14 IR IN A/B and OUT

A commercially available IR receiver can be connected to the IR IN A or B jack, allowing you to control the AV receiver while you're in Zone 2, or control it when it's out of sight, for example, installed in a cabinet.

A commercially available IR emitter can be connected to the IR OUT jack to pass IR (infrared) remote control signals through to other components.

15 ETHERNET

This port is for connecting the AV receiver to home automation equipment and external controllers. Use only shielded Ethernet cables.

16 12V TRIGGER OUT (A/B/C)

These outputs can be connected to the 12-volt trigger inputs on other components.

17 AC INLET

The supplied power cord is connected here. The other end of the power cord should be connected to a suitable wall outlet.

18 DIGITAL COAXIAL IN 1, 2, and 3

These coaxial digital audio inputs are for connecting components with a coaxial digital audio output, such as a CD player or DVD player. They're assignable, which means you can assign each one to an input selector to suit your setup. See "Digital Input Setup" on page 50.

19 DIGITAL OPTICAL IN 1, 2, and OUT

These optical digital audio inputs are for connecting components with an optical digital audio output, such as a CD player or DVD player. They're assignable, which means you can assign each one to an input selector to suit your setup. See "Digital Input Setup" on page 50.

The optical digital audio output is for connecting a digital recorder with an optical digital input, such as a CD recorder.

20 GND screw

This screw is for connecting a turntable's ground wire.

21 CD IN

This analog audio input is for connecting a CD player's analog audio output.

22 TAPE IN/OUT

These analog audio input and output jacks are for connecting a recorder with an analog audio input and output, such as a cassette deck, MD recorder, etc.

23 AUX 1 IN

A VCR for playback only or other video source can be connected here. There's S-Video and composite video input jacks for connecting the video signal.

24 GAME/TV IN

A game console or TV output can be connected here. There's S-Video and composite video input jacks for connecting the video signal.

25 CBL/SAT IN

A cable or satellite receiver can be connected here. There's S-Video and composite video input jacks for connecting the video signal.

26 VCR/DVR IN/OUT

A video component, such as a VCR or DVR, can be connected here for recording and playback. There's S-Video and composite video input and output jacks for connecting the video signal.

27 DVD IN

This input is for connecting a DVD player. There's S-Video and composite video input jacks for connecting the video signal.

28 FRONT L/R, CENTER, SURR L/R, and SURR BACK L/R SPEAKERS

These terminal posts are for connecting the front L/R, center, surround L/R, and surround back L/R speakers.

The FRONT L/R and SURR BACK L/R terminal posts can be used with front speakers and surround back speakers respectively, or used to bi-amp the front speakers. See "Bi-amping the Front Speakers" on page 23.

29 MULTI CH input: FRONT L/R, CENTER, SUBWOOFER, SURR L/R, and SURR BACK L/R

This analog multichannel input is for connecting a component with a 5.1/7.1-channel analog audio output, such as a DVD player, DVD-Audio or SACD-capable player, or an MPEG decoder.

30 PRE OUT: FRONT L/R, CENTER, SUBWOOFER, SURR L/R, and SURR BACK L/R

This 5.1/7.1 multichannel analog audio output can be connected to the analog audio input on a multichannel power amplifier for when you want to use the AV receiver solely as a preamplifier. The SUBWOOFER jack is for connecting a powered subwoofer.

31 PRE OUT: ZONE 2, ZONE 3

These analog audio outputs can be connected to the line inputs on amplifiers in Zone 2 and Zone 3. The SW jacks can be connected to the inputs on powered subwoofers in Zone 2 and Zone 3.

32 ZONE 2 L/R SPEAKERS

These terminal posts are for connecting speakers in Zone 2.

33 AC OUTLET (North American model only)

These switched AC outlets can be used to supply power to other AV components. The type and number of outlets depends on the country in which you purchased your AV receiver.

See pages 20–42 for hookup information.

Remote Controller

Installing the Batteries

- 1 To open the battery compartment, press the small hollow and slide open the cover.**

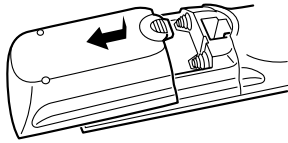

- 2 Insert the three supplied batteries (AA/R6) in accordance with the polarity diagram inside the battery compartment.**

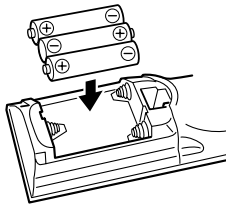

- 3 Slide the cover shut.**

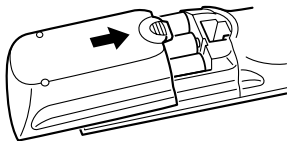

Notes:

- If the remote controller doesn't work reliably, try replacing the batteries.
- Don't mix new and old batteries or different types of batteries.
- If you intend not to use the remote controller for a long time, remove the batteries to prevent damage from leakage or corrosion.
- Expired batteries should be removed as soon as possible to prevent damage from leakage or corrosion.

Using the Remote Controller

When using the remote controller, point it toward the AV receiver's remote control sensor, as shown below.

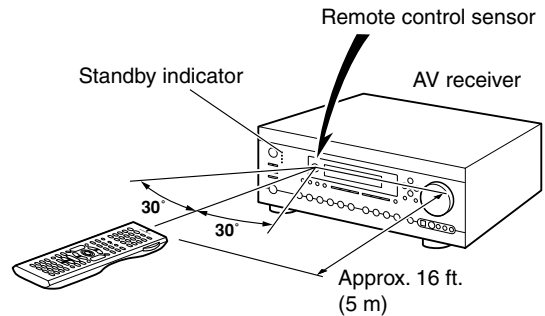

Notes:

- The remote controller may not work reliably if the AV receiver is subjected to bright light, such as direct sunlight or inverter-type fluorescent lights. Keep this in mind when installing.
- If another remote controller of the same type is used in the same room, or the AV receiver is installed close to equipment that uses infrared rays, the remote controller may not work reliably.
- Don't put anything on top of the remote controller, such as a book or magazine, because a button may be pressed continuously, thereby draining the batteries.
- The remote controller may not work reliably if the AV receiver is installed in a rack behind colored glass doors. Keep this in mind when installing.
- The remote controller will not work if there's an obstacle between it and the AV receiver's remote control sensor.

About the Remote Controller Modes

As well as the AV receiver, you can also use the remote controller to control your other AV components. The remote controller has a specific operating mode for use with each type of component. Modes are selected by using the Remote Mode buttons.

Receiver/Tape Mode

In Receiver/Tape mode, you can control the AV receiver and an Onkyo cassette recorder connected via **RI**.

DVD Mode

By default, you can control an Integra/Onkyo DVD player in this mode. By entering the appropriate remote control code, you can control components made by other manufacturers (see page 119).

CD/CDR/MD Mode

By default, you can control an Integra/Onkyo CD player in this mode. By entering the appropriate remote control code, you can control a CD player, MD recorder, or CD recorder made by another manufacturer (see page 119).

Dock Mode

This mode is for controlling an Apple iPod in an Onkyo RI Dock.

By default, you can control an RI Dock that has a remote control sensor such as DS-A2. When operating an RI Dock with **RI** connection, you can control it by entering the appropriate remote control code (see page 119).

TV and VCR Modes

With these modes, you can control a TV and VCR. You must enter the appropriate remote control code first (see page 119).

Cable/SAT Mode

In Cable/SAT mode, you can control a cable or satellite TV receiver. You must enter the appropriate remote control code first (see page 119).

Zone 2/Zone 3 Modes

These modes are for controlling Zone 2 and Zone 3 (see page 115).

1 Use the Remote Mode buttons to select a mode.

2 Use the buttons supported by that mode to control the component.

Receiver/Tape mode: see page 15

DVD mode: see page 17

CD/MD/CDR mode: see page 18

Dock mode: see page 19

TV, VCR, Cable/SAT modes: see page 121

Receiver/Tape Mode

Receiver/Tape mode is used to control the AV receiver. It can also be used to control an Onkyo cassette recorder connected via **RI**.

To set the remote controller to Receiver/Tape mode, press the [Receiver] Remote Mode button.

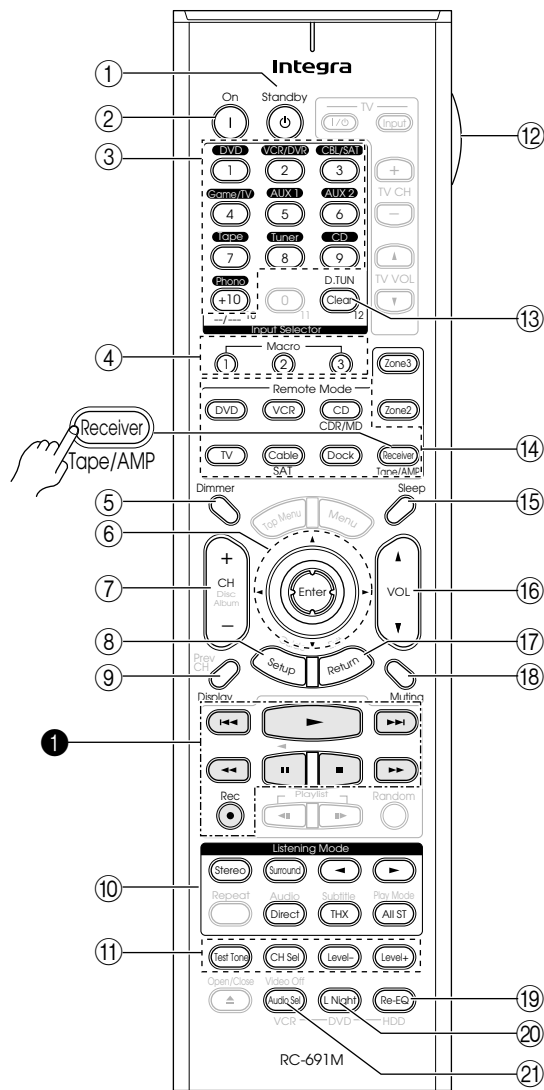

Note:

- Some of the remote controller functions described in this manual may not work as expected with other components.

For detailed information, see the pages in parentheses.

- ① **Standby button (43)**
Sets the AV receiver to Standby.
- ② **On button (43)**
Turns on the AV receiver.
- ③ **Input Selector buttons (60)**
Used to select the input source.
- ④ **Macro buttons (123)**
Used with the Macro function.
- ⑤ **Dimmer button (79)**
Adjusts the display brightness.
- ⑥ **Arrow [▲]/[▼]/[◀]/[▶] and Enter buttons**
Used to select and adjust settings.
- ⑦ **CH +/- button (78)**
Selects radio presets.
- ⑧ **Setup button**
Used to change settings.
- ⑨ **Display button (80)**
Displays information about the current input source.
- ⑩ **Listening Mode buttons (82)**
Used to select the listening modes. The [Stereo], [Surround], and Listening Mode [◀]/[▶] buttons can be used at any time, regardless of the currently selected remote controller mode.
- ⑪ **Test Tone, CH Sel, Level-, and Level+ buttons (79, 100)**
Used to adjust the level of each speaker.
- ⑫ **Light button**
Turns the remote controller's illuminated buttons on or off.
- ⑬ **D.TUN button (62)**
Selects the Direct tuning mode for radio.
- ⑭ **Remote Mode buttons (15)**
Used to select the remote controller modes. When you press a button, the Remote Mode button for the currently selected mode lights up.
- ⑮ **Sleep button (80)**
Used with the Sleep function.
- ⑯ **VOL [▲]/[▼] button (60)**
Adjusts the volume of the AV receiver regardless of the currently selected remote controller mode.
- ⑰ **Return button**
Returns to the previous display when changing settings.
- ⑱ **Muting button (79)**
Mutes or unmutes the AV receiver.
- ⑲ **Re-EQ button (91)**
Turns the Re-EQ function on or off.

⑳ **L Night button (91)**

Turns the Late Night function on or off.

㉑ **Audio Sel button (81)**

Selects the audio input: analog, digital, HDMI, or multichannel.

■ **TAPE mode**

On twin cassette decks, only Deck B can be controlled.

① **Previous and Next [◀◀]/[▶▶] buttons**

The Previous [◀◀] button selects the previous track. During playback it selects the beginning of the current track. The Next [▶▶] button selects the next track.

Depending on how they were recorded, the Previous and Next [◀◀]/[▶▶] buttons may not work properly with some cassette tapes.

Play [▶] button

Starts playback.

Rewind and Fast Forward [◀◀]/[▶▶] buttons

The Rewind [◀◀] button starts rewind. The Fast Forward [▶▶] button starts fast forward.

Reverse Play [◀] button

Starts reverse playback.

Stop [■] button

Stops playback.

Rec [●] button

Starts recording.

DVD Mode

To set the remote controller to DVD mode, press the [DVD] Remote Mode button.

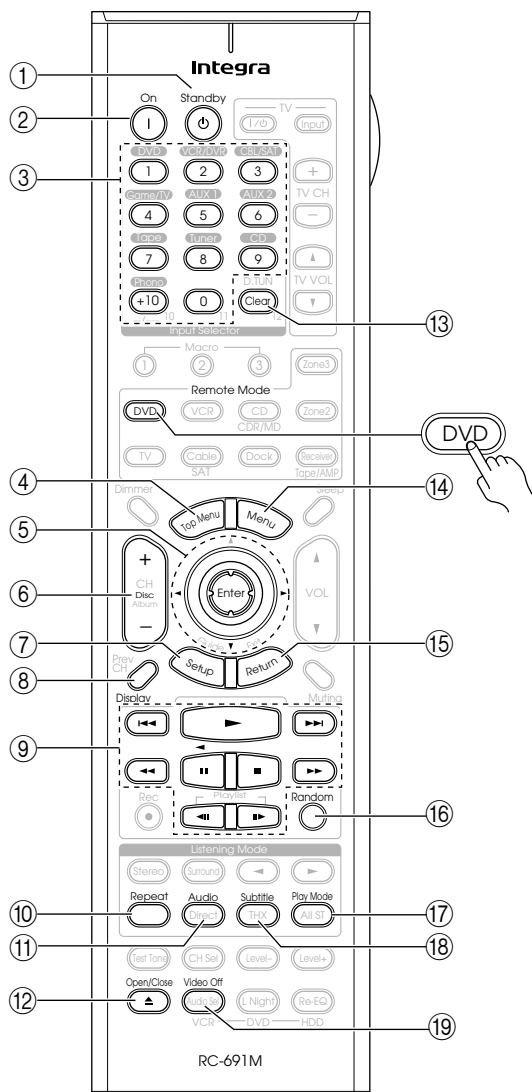

- ① **Standby button**
Sets the DVD player to Standby.
- ② **On button**
Turns on the DVD player.
- ③ **Number buttons**
Used to enter title, chapter, and track numbers, and to enter times for locating specific points.
- ④ **Top Menu button**
Selects a DVD's top menu.
- ⑤ **Arrow [▲]/[▼]/[◀]/[▶] and Enter buttons**
Used to navigate menus and select items.
- ⑥ **Disc +/- button**
Selects discs on a DVD changer.
- ⑦ **Setup button**
Used to access the DVD player's settings.
- ⑧ **Display button**
Displays information about the current disc, title, chapter, or track, including elapsed time, remaining time, total time, and so on.
- ⑨ **Playback buttons**
From left to right: Previous, Play, Next, Rewind, Pause, Stop, Fast Forward, Slow Reverse, and Slow Forward.
- ⑩ **Repeat button**
Used with the repeat playback function.
- ⑪ **Audio button**
Selects foreign language soundtracks and audio formats (e.g., Dolby Digital or DTS).
- ⑫ **Open/Close [▲] button**
Opens and closes the disc tray.
- ⑬ **Clear button**
Cancels functions and clears entered numbers.
- ⑭ **Menu button**
Displays a DVD's menu.
- ⑮ **Return button**
Exits the DVD player's onscreen setup menu.
- ⑯ **Random button**
Used with the random playback function.
- ⑰ **Play Mode button**
Selects play modes on components with selectable play modes.
- ⑱ **Subtitle button**
Selects subtitles.
- ⑲ **Video Off button**
Turns off the internal video circuitry, eliminating any possibility of interference.

CD/MD/CDR Modes

To control an Integra/Onkyo CD player, MD recorder, or CD recorder, or a CD or MD player/recorder made by another manufacturer, press the [CD] Remote Mode button to select the CD/MD/CDR remote controller mode.

In order to control an Onkyo MD recorder or CD recorder, or a component made by another manufacturer, you must first enter the appropriate remote control code (see page 119).

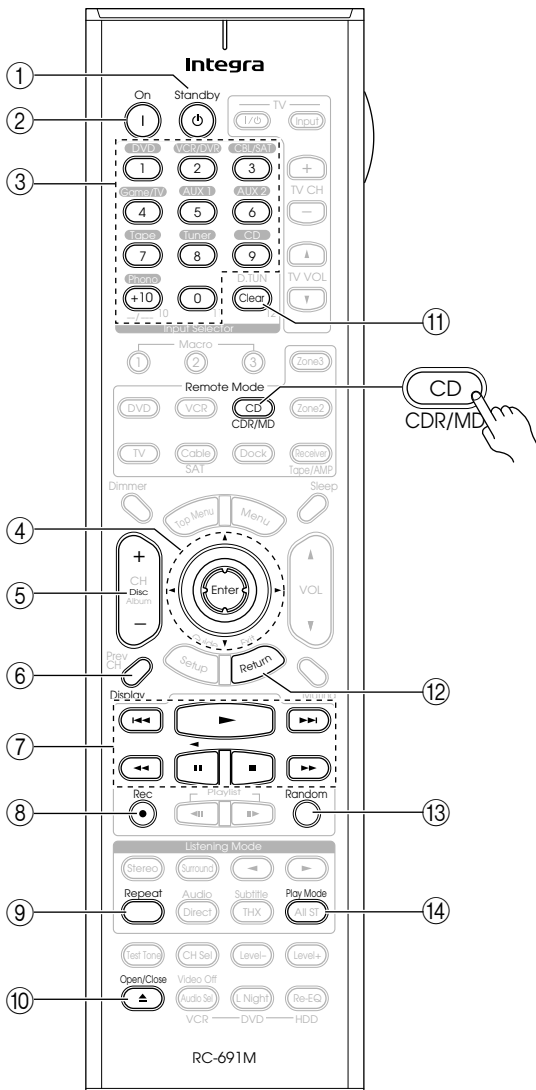

- ① **Standby button**
Sets the component to Standby.
- ② **On button**
Set the component to On or Standby.
- ③ **Number buttons**
Used to enter track numbers and times for locating specific points.
- ④ **Arrow [▲]/[▼]/[◀]/[▶] and Enter buttons**
Used with some components.
- ⑤ **Disc +/- button**
Selects discs on a CD changer.
- ⑥ **Display button**
Displays information about the current disc or track, including elapsed time, remaining time, total time, and so on.
- ⑦ **Playback buttons**
From left to right: Previous, Play, Next, Rewind, Pause, Stop, and Fast Forward.
- ⑧ **Rec [●] button**
Starts recording.
- ⑨ **Repeat button**
Used with the repeat playback function.
- ⑩ **Open/Close [▲] button**
Opens or closes the disc tray or ejects the MiniDisc.
- ⑪ **Clear button**
Cancels functions and clears entered numbers.
- ⑫ **Return button**
Used with some components.
- ⑬ **Random button**
Used with the random playback function.
- ⑭ **Play Mode button**
Selects play modes on components with selectable play modes.

Dock Mode

Dock mode is for controlling an Apple iPod in an Onkyo RI Dock.

When Using an RI Dock:

- Connect the RI Dock to the TAPE IN or GAME/TV IN L/R jacks.
- Set the RI Dock's RI MODE switch to HDD or HDD/DOCK.
- Set the AV receiver's Input Display to DOCK (see page 49).
- When operating a DS-A1 RI Dock, enter the appropriate remote control code for the first time (see page 119).
- See to the RI Dock's instruction manual for more information.

To set the remote controller to DOCK mode, press the [DOCK] REMOTE MODE button.

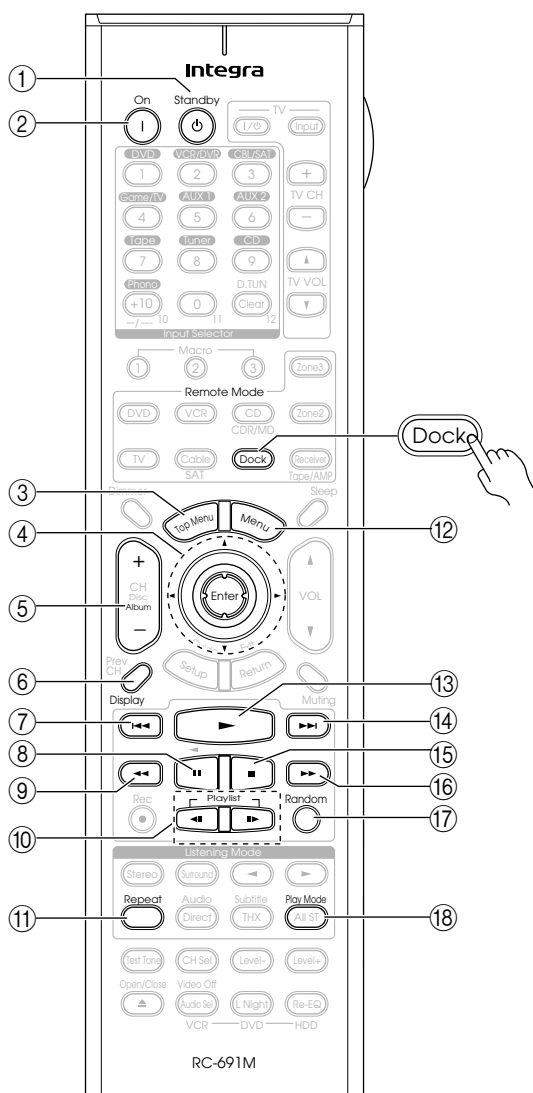

- Standby button**
Turns off the iPod.
- On button***
Turns on the iPod.
- Top Menu button**
Works as a Mode button when used with a DS-A2 RI Dock.
- Arrow [▲]/[▼] and Enter buttons***
Used to navigate menus and select items.
- Album +/- button***
Selects the next or previous album.
- Display button***
Turns on the backlight for 30 seconds.
- Previous [◀◀] button**
Restarts the current song. Press it twice to select the previous song.
- Pause [||] button**
Pauses playback. (With 3rd generation iPods, it works as a Play/Pause button.)
- Rewind [◀◀] button**
Press and hold to rewind.
- Playlist [◀|||]/[|||▶] buttons***
Used to select the previous or next playlist on the iPod.
- Repeat button***
Used with the repeat function.
- Menu button***
Used to access menus.
- Play [▶] button**
Starts playback. If the component is off, it will turn on automatically. (With 3rd generation iPods, this button works as a Play/Pause button.)
- Next [▶▶] button**
Selects the next song.
- Stop [■] button**
Stops playback and displays a menu.
- Fast Forward [▶▶] button**
Press and hold to fast forward.
- Random button***
Used with the shuffle function.
- Play Mode button**
Used to select play modes on components with selectable play modes.
Works as a Resume button when used with a DS-A2 RI Dock.

Buttons marked with an asterisk () are not supported by 3rd generation iPods.

Connecting Your Speakers

Enjoying Home Theater

Thanks to the AV receiver's superb capabilities, you can enjoy surround sound with a real sense of movement in your own home—just like being in a movie theater or concert hall. You can enjoy DVDs featuring Dolby Digital or DTS. With analog or digital TV, you can enjoy Dolby Pro Logic IIx, DTS Neo:6, or Onkyo's original DSP listening modes. You can also enjoy THX Surround EX (THX-certified THX speaker system recommended).

Front left and right speakers

These output the main sound. Their role in a home theater is to provide a solid anchor for the sound image. They should be positioned facing the listener at about ear level, and equally spaced from the TV. Angle them inward slightly so as to create a triangle, with the listener at the apex.

Center speaker

This speaker enhances the front left and right speakers, making sound movements distinct and providing a full sound image. For movies it's used mainly for dialog.

Position it close to your TV (preferably on top) facing forward at about ear level, or at the same height as the front left and right speakers.

Subwoofer

The subwoofer handles the bass sounds of the LFE (Low-Frequency Effects) channel. The volume and quality of the bass output from your subwoofer will depend on its position, the shape of your listening room, and your listening position. In general, a good bass sound can be obtained by installing the subwoofer in a front corner, or at one-third the way along the front wall, as shown.

Tip: To find the best position for your subwoofer, while playing a movie or some music with good bass, experiment by placing your subwoofer at various positions within the room and choose the one that provides the most satisfying results.

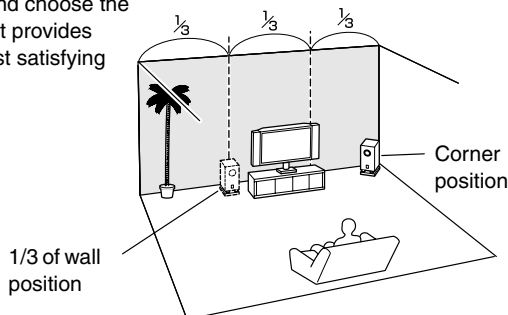

Surround left and right speakers

These speakers are used for precise sound positioning and to add realistic ambience.

Position them at the sides of the listener, or slightly behind, about 2–3 feet (60–100 cm) above ear level. Ideally they should be equally spaced from the listener.

Surround back left and right speakers

These speakers are necessary to enjoy Dolby Digital EX, DTS-ES Matrix, DTS-ES Discrete, THX Surround EX, etc. They enhance the realism of surround sound and improve sound localization behind the listener. Position them behind the listener about 2–3 feet (60–100 cm) above ear level.

Connecting Your Speakers—Continued

Connecting Your Speakers

Speaker Configuration

For the best surround-sound experience, you should connect seven speakers and a powered subwoofer.

The following table shows which channels you should use based on the number of speakers you have.

Number of speakers:	2	3	4	5	6	7
Front left	✓	✓	✓	✓	✓	✓
Front right	✓	✓	✓	✓	✓	✓
Center		✓		✓	✓	✓
Surround left			✓	✓	✓	✓
Surround right			✓	✓	✓	✓
Surround back*					✓	
Surround back left						✓
Surround back right						✓

* If you're using only one surround back speaker, connect it to the SURR BACK L terminals.

No matter how many speakers you use, a powered subwoofer is recommended for a powerful and solid bass.

To get the best from your surround-sound system, you must set the speaker settings. You can do this automatically (see page 53) or manually (see page 96).

Using Dipole Speakers

You can use dipole speakers for the surround left and right and surround back left and right speakers. Dipole speakers output the same sound in two directions.

Dipole speakers typically have an arrow printed on them to indicate how they should be positioned. The surround left and right dipole speakers should be positioned so that their arrows point toward your TV or screen, while the surround back left and right dipolar speakers should be positioned so that their arrows point toward each other, as shown.

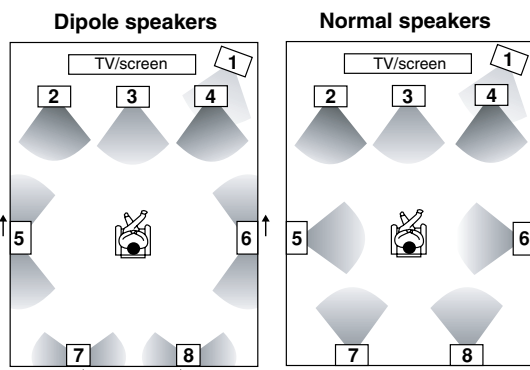

1. Subwoofer
2. Front left speaker
3. Center speaker
4. Front right speaker
5. Surround left speaker
6. Surround right speaker
7. Surround back left speaker
8. Surround back right speaker

Connecting a Powered Subwoofer

Using a suitable cable, connect the AV receiver's SUBWOOFER PRE OUT to the input on your powered subwoofer. If your subwoofer is unpowered and you're using an external amplifier, connect the SUBWOOFER PRE OUT to the amp's input.

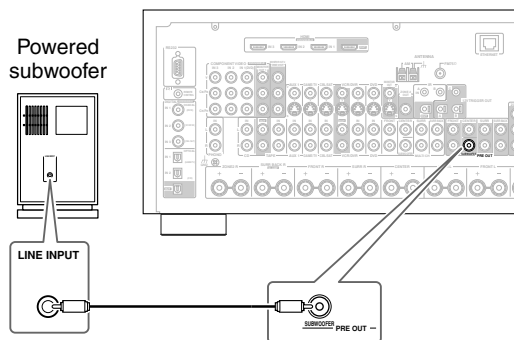

Attaching the Speaker Labels

The AV receiver's positive (+) speaker terminals are color-coded for ease of identification. (The negative (-) speaker terminals are all black.)

Speaker terminal	Color
Front left, Zone 2 left	White
Front right, Zone 2 right	Red
Center	Green
Surround left	Blue
Surround right	Gray
Surround back left	Brown
Surround back right	Tan

The supplied speaker labels are also color-coded and you should attach them to the positive (+) side of each speaker cable in accordance with the above table. All you need to do then is to match the color of each label to the corresponding speaker terminal.



Connecting Your Speakers—Continued

Speaker Connection Precautions

Read the following before connecting your speakers:

- You can connect speakers with an impedance of between 4 and 16 ohms. If the impedance of any of the connected speakers is 4 ohms or more but less than 6, be sure to set the speaker impedance to 4 ohms (see page 44). If you use speakers with a lower impedance, and use the amplifier at high volume levels for a long period of time, the built-in amp protection circuit may be activated.
- Disconnect the power cord from the wall outlet before making any connections.
- Read the instructions supplied with your speakers.
- Pay close attention to speaker wiring polarity. Connect positive (+) terminals to only positive (+) terminals, and negative (–) terminals to only negative (–) terminals. If you get them the wrong way around, the sound will be out of phase and will sound unnatural.

- Unnecessarily long or very thin speaker cables may affect the sound quality and should be avoided.
- Be careful not to short the positive and negative wires. Doing so may damage the AV receiver.
- Don't connect more than one cable to each speaker terminal. Doing so may damage the AV receiver.
- Don't connect a speaker to several terminals.

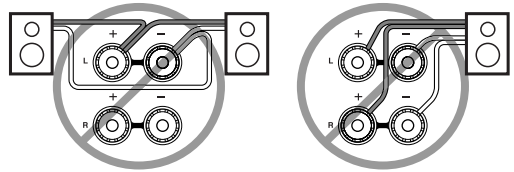
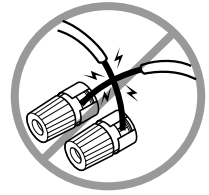

Connecting the Speaker Cables

- 1** Strip about 5/8" (15 mm) of insulation from the ends of the speaker cables, and twist the bare wires tightly, as shown.

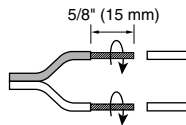

- 2** Unscrew the terminal.



- 3** Fully insert the bare wire.

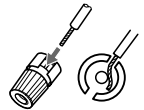

- 4** Screw the terminal tight.



The following illustration shows which speaker should be connected to each pair of terminals.

If you're using only one surround back speaker, connect it to the SURR BACK L terminals.

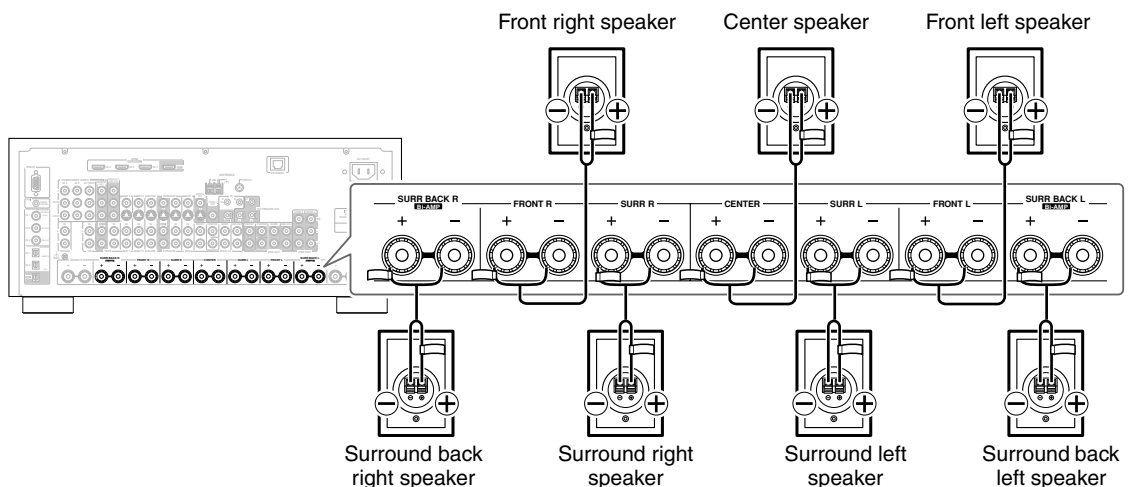

Bi-amping the Front Speakers

The FRONT L/R and SURR BACK L/R terminal posts can be used with front speakers and surround back speakers respectively, or bi-amped to provide separate tweeter and woofer feeds for a pair of front speakers that support bi-amping, providing improved bass and treble performance.

- When bi-amping is used, the AV receiver is able to drive up to 5.1 speakers in the main room.
- For bi-amping, the FRONT L/R terminal posts connect to the front speakers' tweeter terminals. And the SURR BACK L/R terminal posts connect to the front speakers' woofer terminals.
- Once you've completed the bi-amping connections shown below and turned on the AV receiver, you must set the Speaker Type setting to Bi-Amp to enable bi-amping (see page 44).

Important:

- **When making the bi-amping connections, be sure to remove the jumper bars that link the speakers' tweeter (high) and woofer (low) terminals.**
- Bi-amping can only be used with speakers that support bi-amping. Refer to your speaker manual.

Bi-amping Speaker Hookup

- 1 Connect the AV receiver's FRONT R positive (+) terminal to the right speaker's positive (+) tweeter (high) terminal. And connect the AV receiver's FRONT R negative (-) terminal to the right speaker's negative (-) tweeter (high) terminal.
- 2 Connect the AV receiver's SURR BACK R positive (+) terminal to the right speaker's positive (+) woofer (low) terminal. And connect the AV receiver's SURR BACK R negative (-) terminal to the right speaker's negative (-) woofer (low) terminal.
- 3 Connect the AV receiver's FRONT L positive (+) terminal to the left speaker's positive (+) tweeter (high) terminal. And connect the AV receiver's FRONT L negative (-) terminal to the left speaker's negative (-) tweeter (high) terminal.
- 4 Connect the AV receiver's SURR BACK L positive (+) terminal to the left speaker's positive (+) woofer (low) terminal. And connect the AV receiver's SURR BACK L negative (-) terminal to the left speaker's negative (-) woofer (low) terminal.

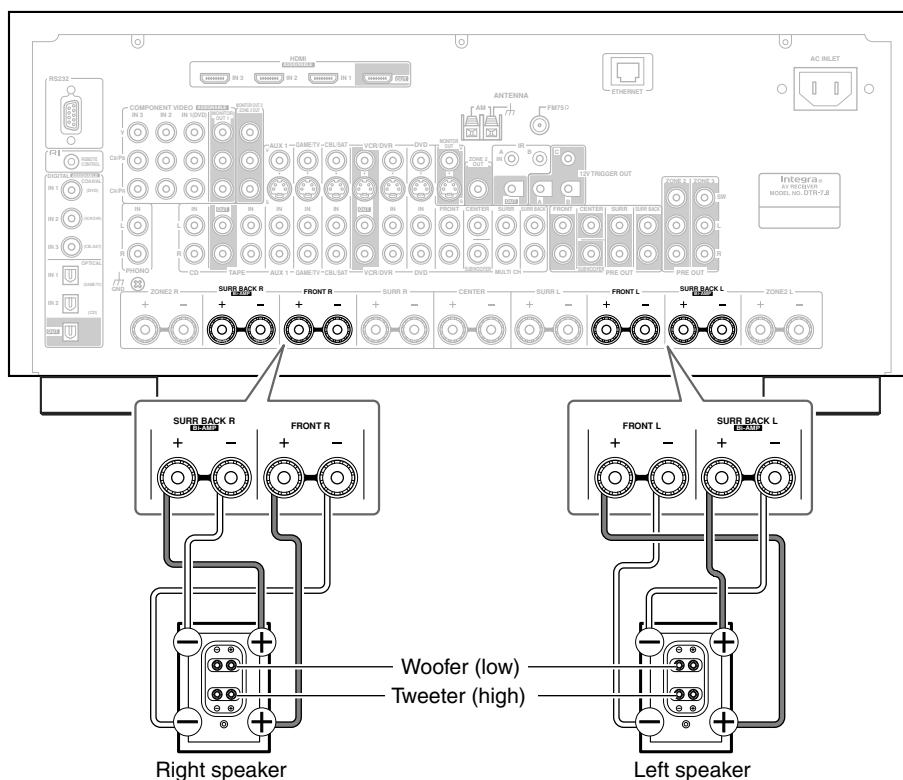

Connecting Antennas

This section explains how to connect the supplied indoor FM antenna and AM loop antenna, and how to connect commercially available outdoor FM and AM antennas.

The AV receiver won't pick up any radio signals without any antenna connected, so you must connect the antenna to use the tuner.

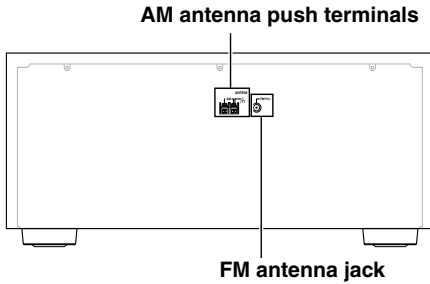

Connecting the Indoor FM Antenna

The supplied indoor FM antenna is for indoor use only.

1 Attach the FM antenna, as shown.

■ American Model

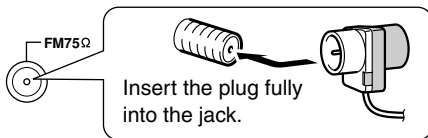

■ Other Models

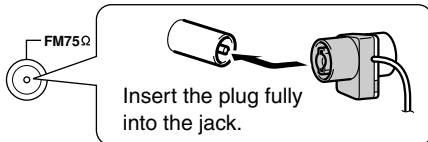

Once your AV receiver is ready for use, you'll need to tune into an FM radio station and adjust the position of the FM antenna to achieve the best possible reception.

2 Use thumbtacks or something similar to fix the FM antenna into position.

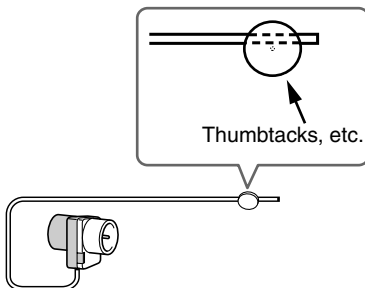

Caution: Be careful that you don't injure yourself when using thumbtacks.

If you cannot achieve good reception with the supplied indoor FM antenna, try a commercially available outdoor FM antenna instead (see page 25).

Connecting the AM Loop Antenna

The supplied indoor AM loop antenna is for indoor use only.

1 Assemble the AM loop antenna, inserting the tabs into the base, as shown.

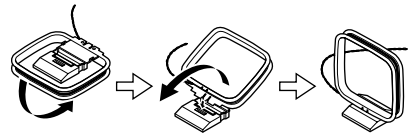

2 Connect both wires of the AM loop antenna to the AM push terminals, as shown.

(The antenna's wires are not polarity sensitive, so they can be connected either way around).

Make sure that the wires are attached securely and that the push terminals are gripping the bare wires, not the insulation.

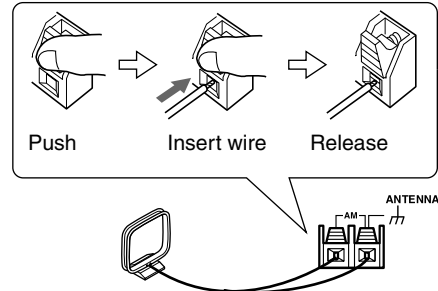

Once your AV receiver is ready for use, you'll need to tune into an AM radio station and adjust the position of the AM antenna to achieve the best possible reception.

Keep the antenna as far away as possible from your AV receiver, TV, speaker cables, and power cords.

If you cannot achieve good reception with the supplied indoor AM loop antenna, try using it with a commercially available outdoor AM antenna (see page 25).

Connecting an Outdoor FM Antenna

If you cannot achieve good reception with the supplied indoor FM antenna, try a commercially available outdoor FM antenna instead.

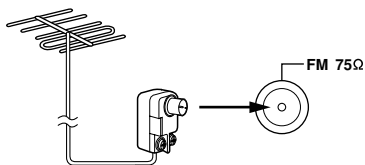

Notes:

- Outdoor FM antennas work best outside, but usable results can sometimes be obtained when installed in an attic or loft.
- For best results, install the outdoor FM antenna well away from tall buildings, preferably with a clear line of sight to your local FM transmitter.
- Outdoor antenna should be located away from possible noise sources, such as neon signs, busy roads, etc.
- For safety reasons, outdoor antenna should be situated well away from power lines and other high-voltage equipment.
- Outdoor antenna must be grounded in accordance with local regulations to prevent electrical shock hazards.

■ Using a TV/FM Antenna Splitter

It's best not to use the same antenna for both FM and TV reception, as this can cause interference problems. If circumstances demand it, use a TV/FM antenna splitter, as shown.

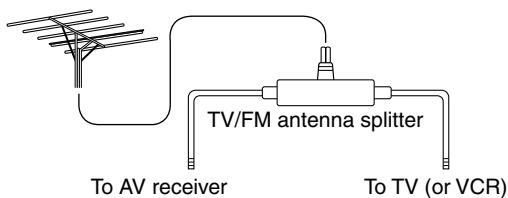

Connecting an Outdoor AM Antenna

If good reception cannot be achieved using the supplied AM loop antenna, an outdoor AM antenna can be used in addition to the loop antenna, as shown.

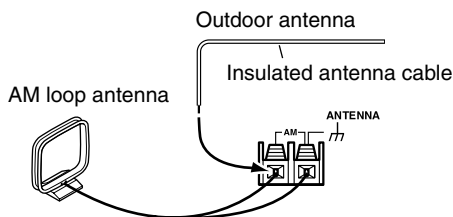

Outdoor AM antennas work best when installed horizontally outside, but good results can sometimes be obtained indoors by mounting horizontally above a window. Note that the AM loop antenna should be left connected.

Outdoor antenna must be grounded in accordance with local regulations to prevent electrical shock hazards.

Connecting Your Components

About AV Connections

- Before making any AV connections, read the manuals supplied with your other AV components.
- Don't connect the power cord until you've completed and double-checked all AV connections.

Optical Digital Jacks

The AV receiver's optical digital jacks have shutter-type covers that open when an optical plug is inserted and close when it's removed. Push plugs in all the way.

Caution: To prevent shutter damage, hold the optical plug straight when inserting and removing.

AV Connection Color Coding

RCA-type AV connections are usually color coded: red, white, and yellow. Use red plugs to connect right-channel audio inputs and outputs (typically labeled "R"). Use white plugs to connect left-channel audio inputs and outputs (typically labeled "L"). And use yellow plugs to connect composite video inputs and outputs.

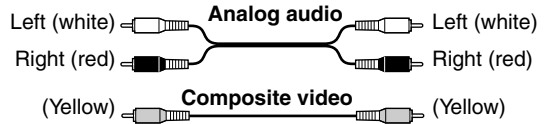

- Push plugs in all the way to make good connections (loose connections can cause noise or malfunctions).
- To prevent interference, keep audio and video cables away from power cords and speaker cables.

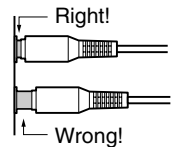

AV Cables and Jacks

Video

	Cable	Jack	Description
HDMI			HDMI connections can carry uncompressed standard- or high-definition digital video and audio and offer the best picture and sound quality.
Component video cable			Component video separates the luminance (Y) and color difference signals (PR, PB), providing the best picture quality. (Some TV manufacturers label their component video jacks slightly differently.)
S-Video cable			S-Video separates the luminance and color signals and provides better picture quality than composite video.
Composite video cable			Composite video is commonly used on TVs, VCRs, and other video equipment.

Audio

Optical digital audio cable			This offers the best sound quality and allows you to enjoy Dolby Digital and DTS. The audio quality is the same as for coaxial.
Coaxial digital audio cable			This offers the best sound quality and allows you to enjoy Dolby Digital and DTS. The audio quality is the same as for optical.
Analog audio cable (RCA)			This cable carries analog audio. It's the most common connection format for analog audio and can be found on virtually all AV components.
Multichannel analog audio cable (RCA)			This cable carries multichannel analog audio and is typically used to connect DVD players with a 7.1-channel analog audio output. Several standard analog audio cables can be used instead of a multichannel cable.

Note: The AV receiver does not support SCART connections.

Connecting Audio and Video Signals to the AV Receiver

By connecting both the audio and video outputs of your DVD player and other AV components to the AV receiver, you can switch the audio and video signals simultaneously simply by changing the input source on the AV receiver.

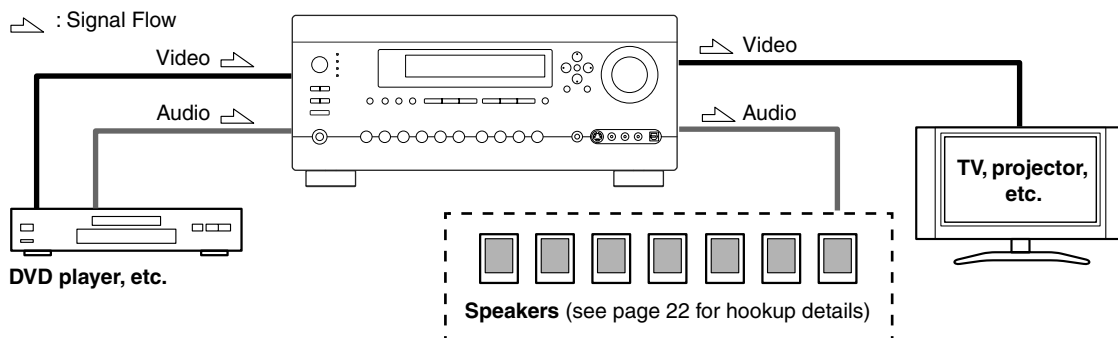

Which Connections Should I Use?

The AV receiver supports several connection formats for compatibility with a wide range of AV equipment. The format you choose will depend on the formats supported by your other components. Use the following sections as a guide.

For video components, you must make an audio connection and a video connection.

Video Connection Formats

Video equipment can be connected to the AV receiver by using any one of the following video connection formats: composite video, S-Video, component video, or HDMI, the latter offering the best picture quality.

The AV receiver can upconvert and downconvert between video formats, depending on the HDMI Monitor setting, which generally determines whether video signals are upconverted for the component video output or the HDMI output.

For optimal video performance, THX recommends that video signals pass through the system without upconversion (e.g., component video input through to component video output). It's also recommended that you set the Immediate Display preference to Off (page 107).

■ HDMI Monitor Setting Set to Yes

With the HDMI Monitor setting set to Yes (see page 45), video input signals flow through the AV receiver as shown, with composite video, S-Video, and component video sources all being upconverted for the HDMI output. Use this setting if you connect the AV receiver's HDMI OUT to your TV.

The composite video, S-Video, and component video outputs pass through their respective input signals as they are.

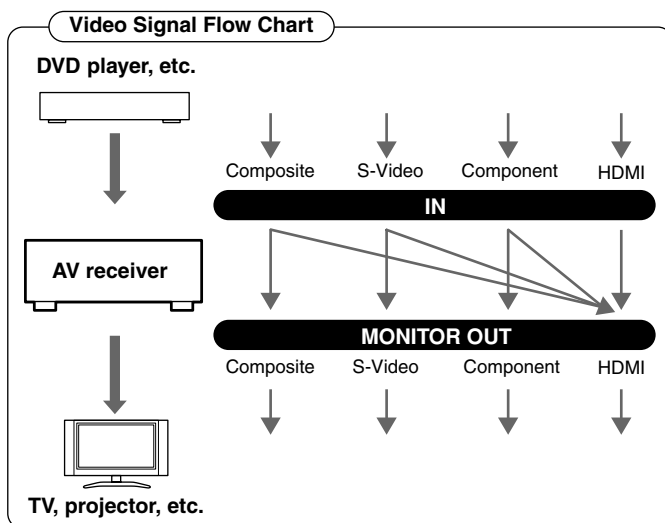

Connecting Your Components—Continued

■ HDMI Monitor Setting Set to No

With the HDMI Monitor setting set to No (see page 45), video input signals flow through the AV receiver as shown, with composite video and S-Video sources being upconverted for the component video output. **Use this setting if you connect the AV receiver's COMPONENT VIDEO MONITOR OUT 1 or COMPONENT VIDEO MONITOR OUT 2/ZONE 2 OUT to your TV.**

Composite video is upconverted to S-Video and S-Video is downconverted to composite video. Note that these conversions only apply to the MONITOR OUT V and S outputs, not the VCR/DVR OUT V and S outputs.

The composite video, S-Video, and component video pass through their respective input signals as they are.

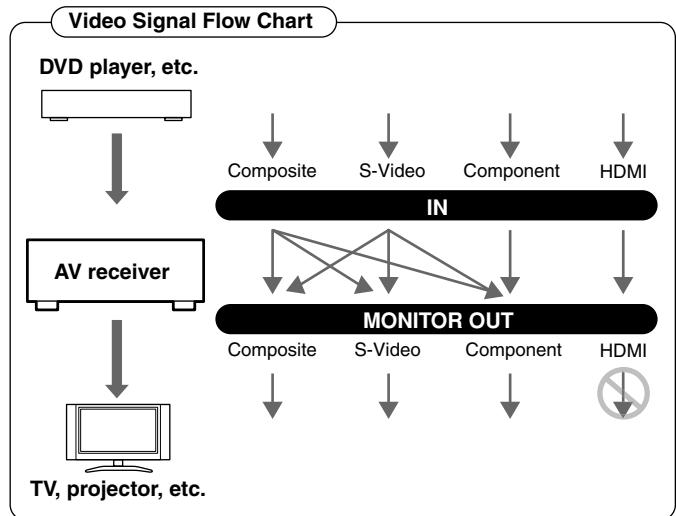

Audio Connection Formats

Audio equipment can be connected to the AV receiver by using any of the following audio connection formats: analog, optical, coaxial, analog multichannel, or HDMI.

When choosing a connection format, bear in mind that the AV receiver does not convert digital input signals for analog line outputs and vice versa. For example, audio signals connected to an optical or coaxial digital input are not output by the analog TAPE OUT.

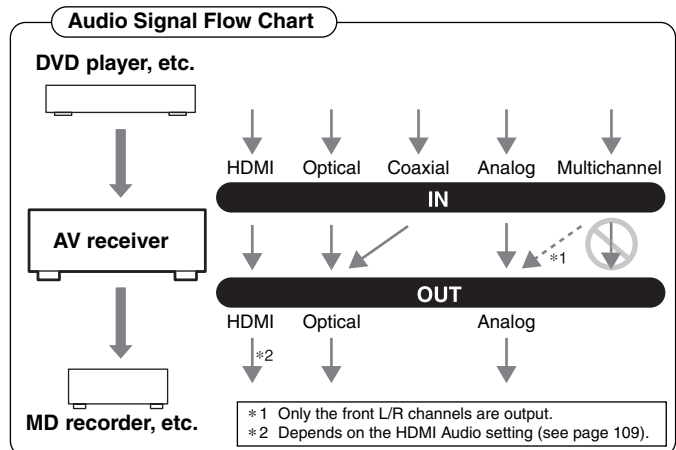

Connecting Your Components—Continued

Connecting a TV or Projector

Step 1: Video Connection

Choose a video connection that matches your TV (**A**, **B**, or **C**), and then make the connection.

Step 2: Audio Connection

Choose an audio connection that matches your TV (**a**, **b**, or **c**), and then make the connection.

- With connection **a**, you can listen to and record audio from your TV or listen in Zone 2 or Zone 3.
- To enjoy Dolby Digital and DTS, use connection **b** or **c**. (To record or listen in Zone 2 or Zone 3 as well, use **a** and **b**, or **a** and **c**.)

Connection	AV receiver	Signal flow	TV	Picture quality
A	COMPONENT VIDEO MONITOR OUT 1	⇒	Component video input	Best
B	MONITOR OUT S	⇒	S-Video input	Better
C	MONITOR OUT V	⇒	Composite video input	Standard
a	GAME/TV IN L/R	←	Analog audio L/R output	
b	DIGITAL COAXIAL IN 2	←	Digital coaxial output	
c	DIGITAL OPTICAL IN 1	←	Digital optical output	

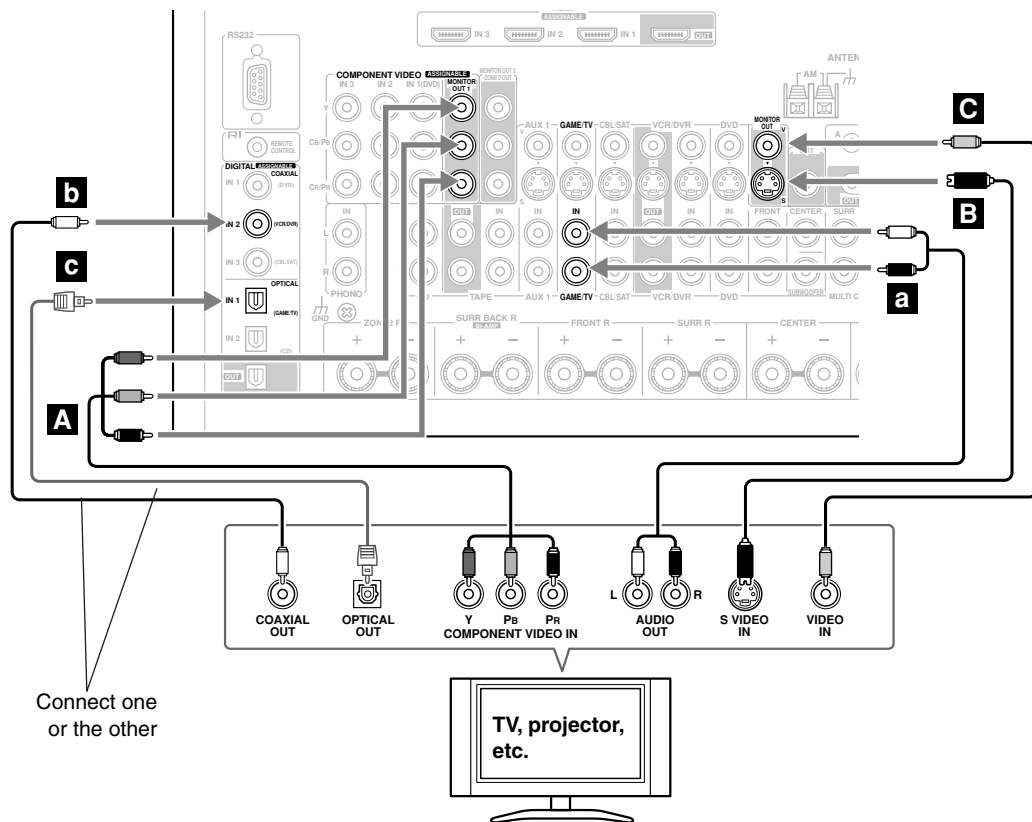

If your TV has no audio outputs, connect an audio output from your VCR or cable or satellite receiver to the AV receiver and use its tuner to listen to TV programs through the AV receiver (see pages 32 and 34).

Connecting a DVD player

Step 1: Video Connection

Choose a video connection that matches your DVD player (**A**, **B**, or **C**), and then make the connection.

If you use connection **A**, you must connect the AV receiver to your TV with the same type of connection.

Step 2: Audio Connection

Choose an audio connection that matches your DVD player (**a**, **b**, or **c**), and then make the connection.

- With connection **a**, you can listen to and record audio from a DVD or listen in Zone 2 or Zone 3.
- To enjoy Dolby Digital and DTS, use connection **b** or **c**. (To record or listen in Zone 2 or Zone 3 as well, use **a** and **b**, or **a** and **c**.)
- If your DVD player has main left and right outputs and multichannel left and right outputs, be sure to use the main left and right outputs for connection **a**.

Connection	AV receiver	Signal flow	DVD player	Picture quality
A	COMPONENT VIDEO IN 1	←	Component video output	Best
B	DVD IN S	←	S-Video output	Better
C	DVD IN V	←	Composite video output	Standard
a	DVD IN L/R	←	Analog audio L/R output	
b	DIGITAL COAXIAL IN 1	←	Digital coaxial output	
c	DIGITAL OPTICAL IN 1	←	Digital optical output	

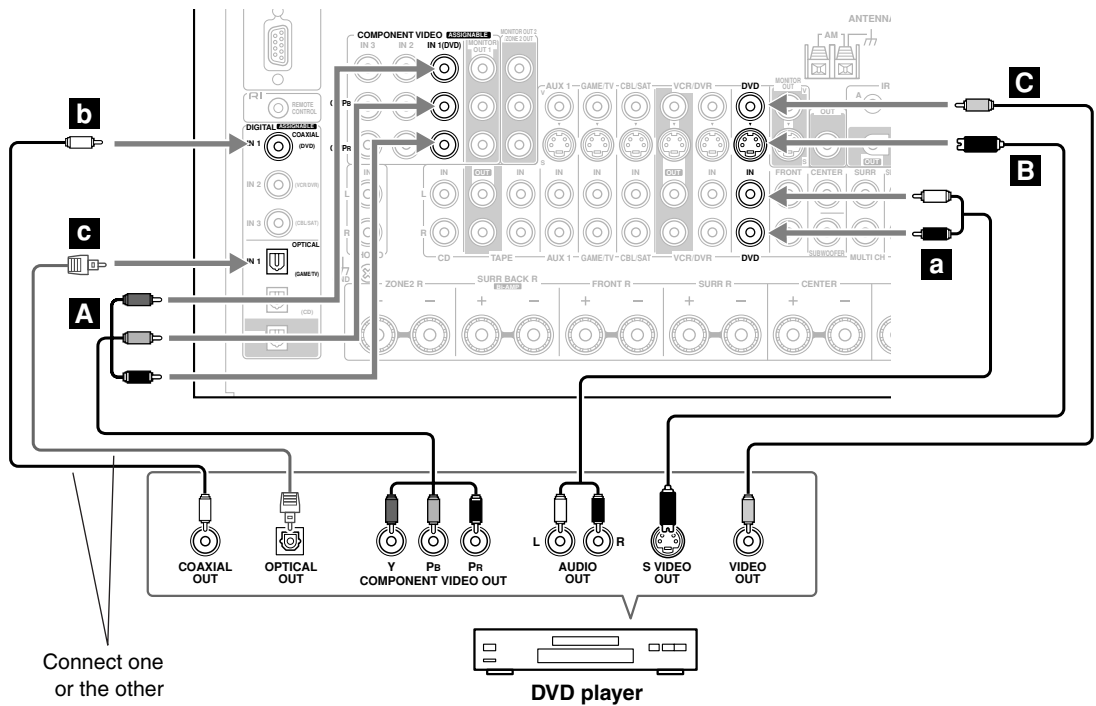

To connect a DVD player or DVD-Audio/SACD-capable player with a multichannel analog audio output, see page 31.

Hooking Up the Multichannel Input

If your DVD player supports multichannel audio formats such as DVD-Audio and SACD, and it has a multichannel analog audio output, you can connect it to the AV receiver's multichannel input.

Use a multichannel analog audio cable, or several normal audio cables, to connect the AV receiver's MULTI CH FRONT L/R, CENTER, SURR L/R, SURR BACK L/R, and SUBWOOFER jacks to the 7.1-channel analog audio output on your DVD player. If your DVD player has a 5.1-channel analog audio output, don't connect anything to the AV receiver's SURR BACK L/R jacks.

Before using the multichannel input, you must assign it to an input selector. See "Analog Input Setup" on page 52. To select the multichannel input, see "Selecting Audio Inputs" on page 81. To adjust the subwoofer sensitivity for the multichannel input, see "Subwoofer Input Sensitivity" on page 109.

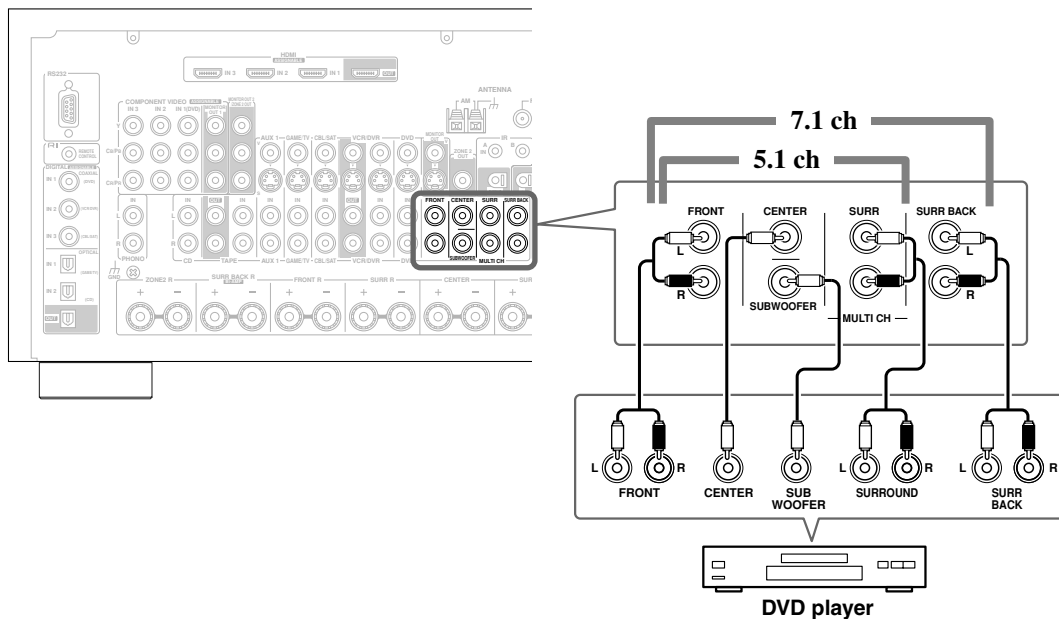

Connecting a VCR or DVR for Playback



With this hookup, you can use the tuner in your VCR or DVR to listen to your favorite TV programs via the AV receiver, which is useful if your TV has no audio outputs.

Step 1: Video Connection

Choose a video connection that matches your VCR or DVR (**A**, **B**, or **C**), and then make the connection. If you use connection **A**, you must connect the AV receiver to your TV with the same type of connection.

Step 2: Audio Connection

Choose an audio connection that matches your VCR or DVR (**a**, **b**, or **c**), and then make the connection.

- With connection **a**, you can listen to the VCR or DVR in Zone 2 or Zone 3.
- To enjoy Dolby Digital and DTS, use connection **b** or **c**. (To listen in Zone 2 or Zone 3 as well, use **a** and **b**, or **a** and **c**.)

Connection	AV receiver	Signal flow	VCR or DVR	Picture quality
A	COMPONENT VIDEO IN 2	←	Component video output	Best
B	VCR/DVR IN S	←	S-Video output	Better
C	VCR/DVR IN V	←	Composite video output	Standard
a	VCR/DVR IN L/R	←	Analog audio L/R output	
b	DIGITAL COAXIAL IN 2	←	Digital coaxial output	
c	DIGITAL OPTICAL IN 1	←	Digital optical output	

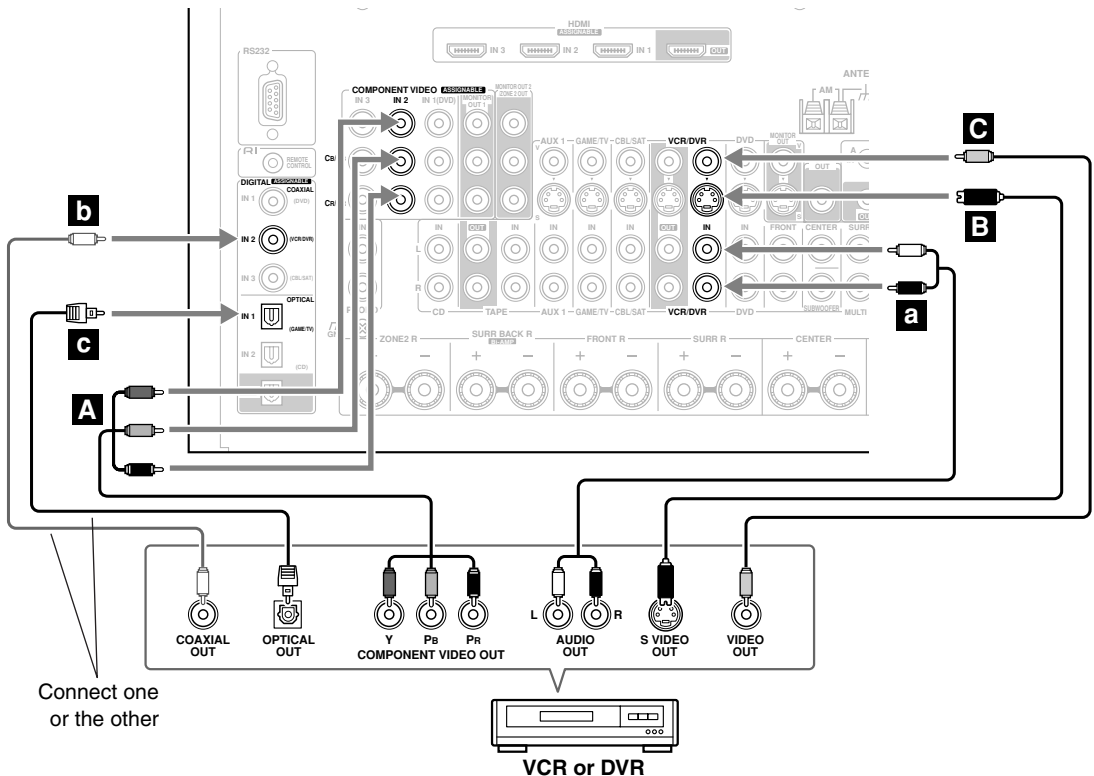

Connecting Your Components—Continued

Connecting a VCR or DVR for Recording

Step 1: Video Connection

Choose a video connection that matches your VCR or DVR (**A** or **B**), and then make the connection. The video source to be recorded must be connected to the AV receiver via the same type of connection.

Step 2: Audio Connection

Choose an audio connection that matches your VCR or DVR (**a** or **b**), and then make the connection.

Connection	AV receiver	Signal flow	VCR or DVD recorder	Picture quality
A	VCR/DVR OUT S	⇒	S-Video input	Better
B	VCR/DVR OUT V	⇒	Composite video input	Standard
a	VCR/DVR OUT L/R	⇒	Audio L/R input	
b	DIGITAL OPTICAL OUT	⇒	Digital optical input	

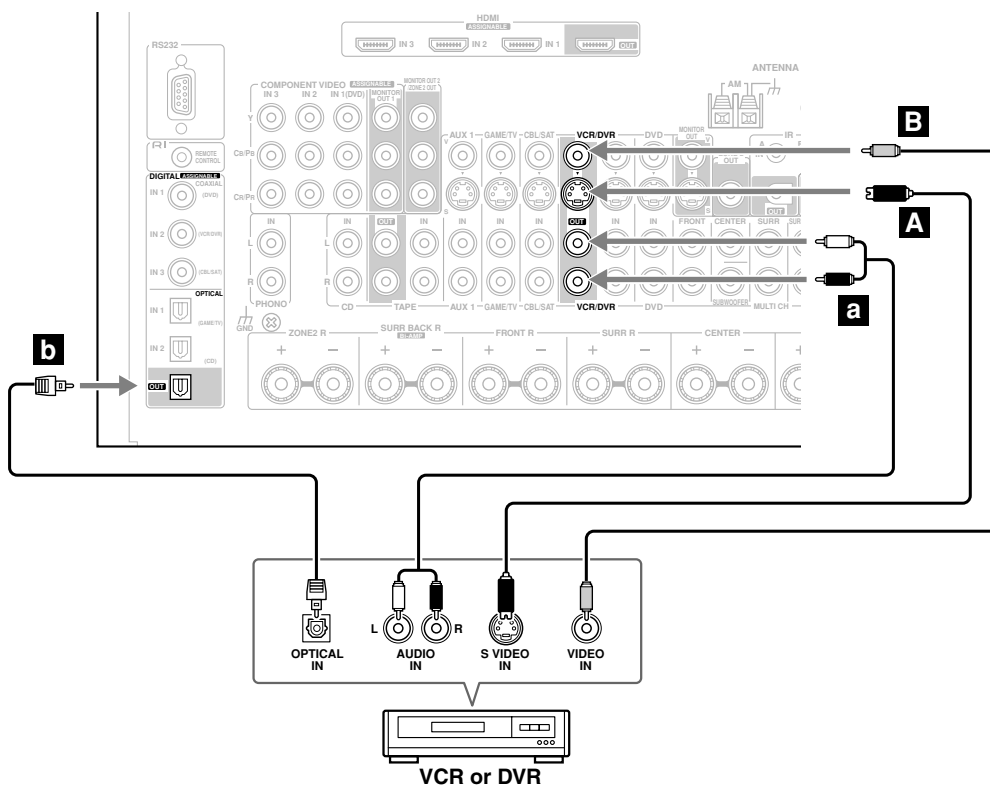

Notes:

- The AV receiver must be turned on for recording. Recording is not possible while it's on Standby.
- If you want to record directly from your TV or another video source without going through the AV receiver, connect the audio and video outputs from your TV or other video component directly to the recording VCR/DVR's audio and video inputs. See the manuals supplied with your TV or VCR/DVR for details.
- Video signals connected to composite video inputs can only be recorded via the VCR/DVR OUT V jack. So if your source TV or VCR is connected to a composite video input, the recording VCR/DVR must be connected to the VCR/DVR OUT V jack. Likewise, video signals connected to S-Video inputs can only be recorded via the VCR/DVR OUT S jack. So if your source TV or VCR is connected to an S-Video input, the recording VCR/DVR must be connected to the VCR/DVR OUT S jack.

Connecting a Satellite, Cable, or Terrestrial Set-top box or Other Video Source



With this hookup, you can use your satellite or cable receiver to listen to your favorite TV programs via the AV receiver, which is useful if your TV has no audio outputs.

Step 1: Video Connection

Choose a video connection that matches the video source (**A**, **B**, or **C**), and then make the connection.

If you use connection **A**, you must connect the AV receiver to your TV with the same type of connection.

Step 2: Audio Connection

Choose an audio connection that matches the video source (**a**, **b**, or **c**), and then make the connection.

- With connection **a**, you can listen to and record audio from the video source or listen in Zone 2 or Zone 3.
- To enjoy Dolby Digital and DTS, use connection **b** or **c**. (To record or listen in Zone 2 or Zone 3 as well, use **a** and **b**, or **a** and **c**.)

Connection	AV receiver	Signal flow	Video source	Picture quality
A	COMPONENT VIDEO IN 3	←	Component video output	Best
B	CBL/SAT IN S	←	S-Video output	Better
C	CBL/SAT IN V	←	Composite video output	Standard
a	CBL/SAT IN L/R	←	Analog audio L/R output	
b	DIGITAL COAXIAL IN 3	←	Digital coaxial output	
c	DIGITAL OPTICAL IN 2	←	Digital optical output	

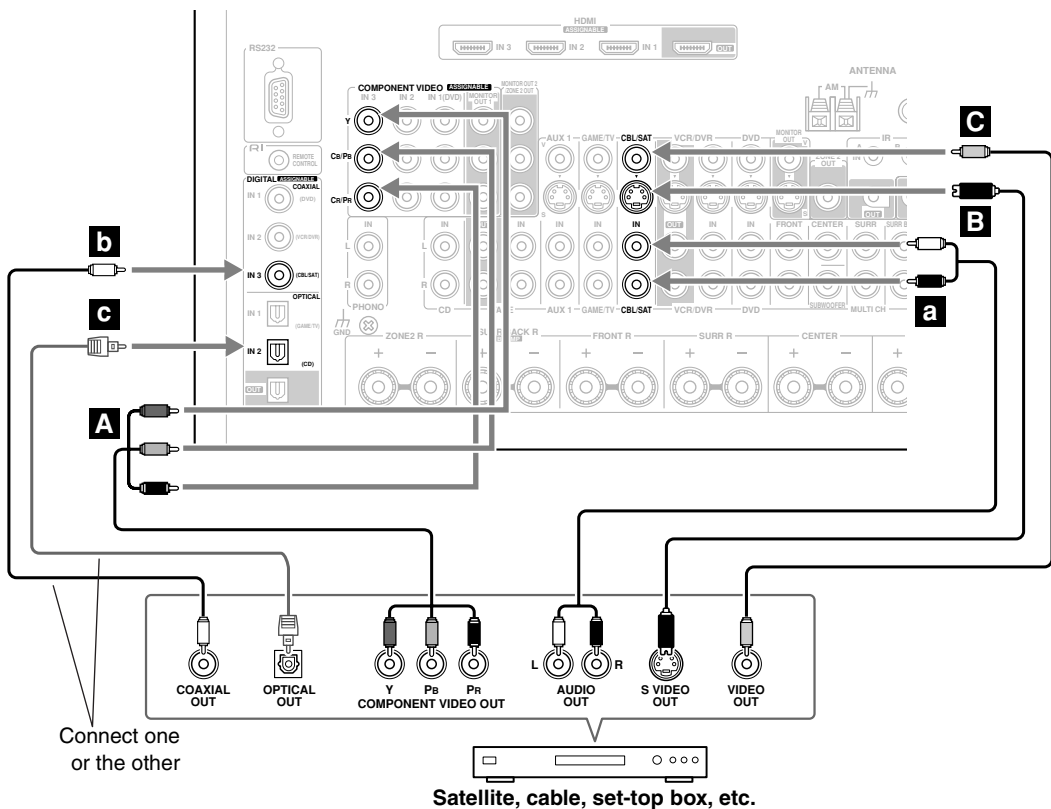

Connecting Components with HDMI

About HDMI

Designed to meet the increased demands of digital TV, HDMI (High Definition Multimedia Interface) is a new digital interface standard for connecting TVs, projectors, DVD players, set-top boxes, and other video components. Until now, several separate video and audio cables have been required to connect AV components. With HDMI, a single cable can carry control signals, digital video, and up to eight channels of digital audio (2-channel PCM, multichannel digital audio, or multichannel PCM).

The HDMI video stream (i.e., video signal) is compatible with DVI (Digital Visual Interface),*¹ so TVs and displays with a DVI input can be connected by using an HDMI-to-DVI adapter cable. (This may not work with some TVs and displays, resulting in no picture.)

The AV receiver uses HDCP (High-bandwidth Digital Content Protection), so only HDCP-compatible components will display a picture.

The AV receiver's HDMI interface is based on the following standard:
High-Definition Multimedia Interface Specification Informational Version 1.3a

Supported Audio Formats

- 2-channel linear PCM (32–192 kHz, 16/20/24 bit)
- Multichannel linear PCM (7.1 ch, 32–192 kHz)
- Bitstream (DSD, Dolby Digital, Dolby Digital Plus, Dolby TrueHD, DTS, DTS-HD High Resolution, DTS-HD Master Audio)

Your DVD player must be able to output these formats from its HDMI OUT.

About Copyright Protection

The AV receiver supports HDCP (High-bandwidth Digital Content Protection),*² a copy-protection system for digital video signals. Other devices connected to the AV receiver via HDMI must also support HDCP.

Use a commercially available HDMI cable (supplied with some components) to connect the AV receiver's HDMI OUT to the HDMI input on your TV or projector.

*1 DVI (Digital Visual Interface): The digital display interface standard set by the DDWG*³ in 1999.

*2 HDCP (High-bandwidth Digital Content Protection): The video encryption technology developed by Intel for HDMI/DVI. It's designed to protect video content and requires a HDCP-compatible device to display the encrypted video.

*3 DDWG (Digital Display Working Group): Lead by Intel, Compaq, Fujitsu, Hewlett Packard, IBM, NEC, and Silicon Image, this open industry group's objective is to address the industry's requirements for a digital connectivity specification for high-performance PCs and digital displays.

Connecting Your Components—Continued

Making HDMI Connections

Step 1: Use HDMI cables to connect the AV receiver's HDMI jacks to your HDMI-compatible DVD player, TV, projector, and so on.

Step 2: Assign each HDMI IN to an input selector. See "HDMI Input Setup" on page 46.

■ Video Signals

Digital video signals received by the HDMI IN jacks are normally output by the HDMI OUT for display on your TV. Composite video, S-Video, and component video sources can be upconverted for the HDMI output. See "Video Connection Formats" on page 27 for more information.

■ Audio Signals

Digital audio signals received by the HDMI IN jacks are output by the speakers and headphones connected to the AV receiver. Normally, they are not output by the HDMI OUT, unless the HDMI Audio Out setting is set to On (see page 109).



To listen to audio received by the HDMI IN jacks through your TV's speakers, set the HDMI Audio Out setting to On (see page 109), and set your DVD player's HDMI audio output setting to PCM.

When listening to audio from an HDMI component through the AV receiver's speakers, set the HDMI component so that its video can be seen on your TV (e.g., on your TV, select the input to which the HDMI component is connected). If your TV is not turned on or a different input is selected, the AV receiver's speakers may produce no sound or the sound may be cut off.

Note:

- When the HDMI Audio setting is set to On (see page 109), or TV Control is set to Enable and you're listening through your TV's speakers, if you turn up the AV receiver's volume control, the sound will be output by the AV receiver's speakers. To stop the AV receiver's speakers producing sound, change the settings, change your TV's settings, or turn down the AV receiver's volume.

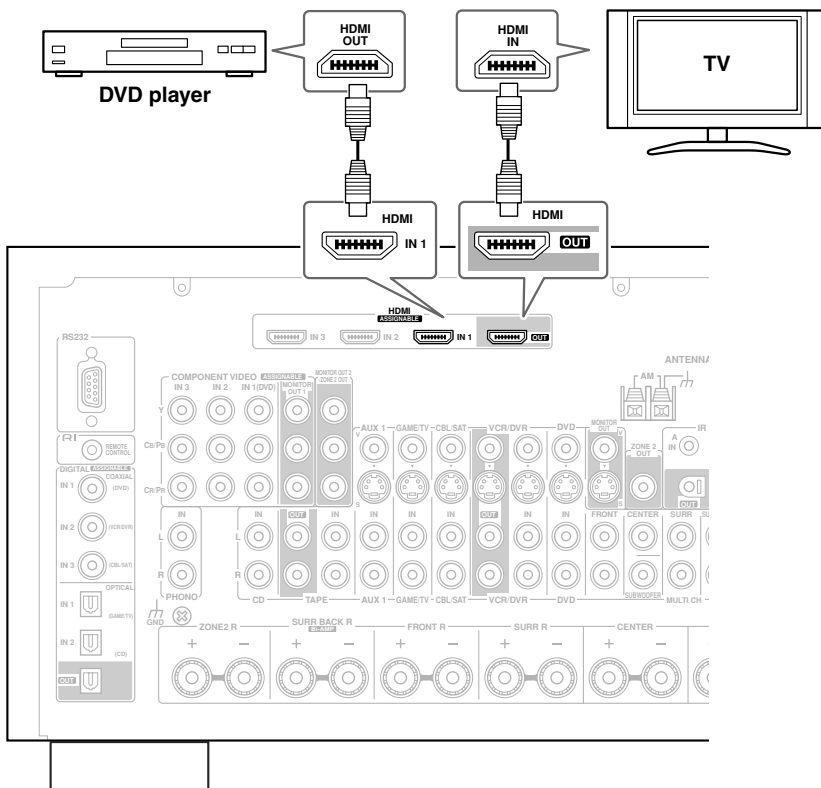

Connecting a Game Console

Step 1: Video Connection

Choose a video connection that matches your game console (**A**, **B**, or **C**), and then make the connection.

If you use connection **A**, you must connect the AV receiver to your TV with the same type of connection.

Step 2: Audio Connection

Choose an audio connection that matches your DVD player (**a**, **b**, or **c**), and then make the connection.

- With connection **a**, you can listen to and record audio from your game console or listen in Zone 2 or Zone 3.
- To enjoy Dolby Digital and DTS, use connection **b**. (To record or listen in Zone 2 or Zone 3 as well, use **a** and **b**.)

Connection	AV receiver	Signal flow	Game console	Picture quality
A	COMPONENT VIDEO IN 3	←	Component video output	Best
B	GAME/TV IN S	←	S-Video output	Better
C	GAME/TV IN V	←	Composite video output	Standard
a	GAME/TV IN L/R	←	Analog audio L/R output	
b	DIGITAL OPTICAL IN 1	←	Digital coaxial output	

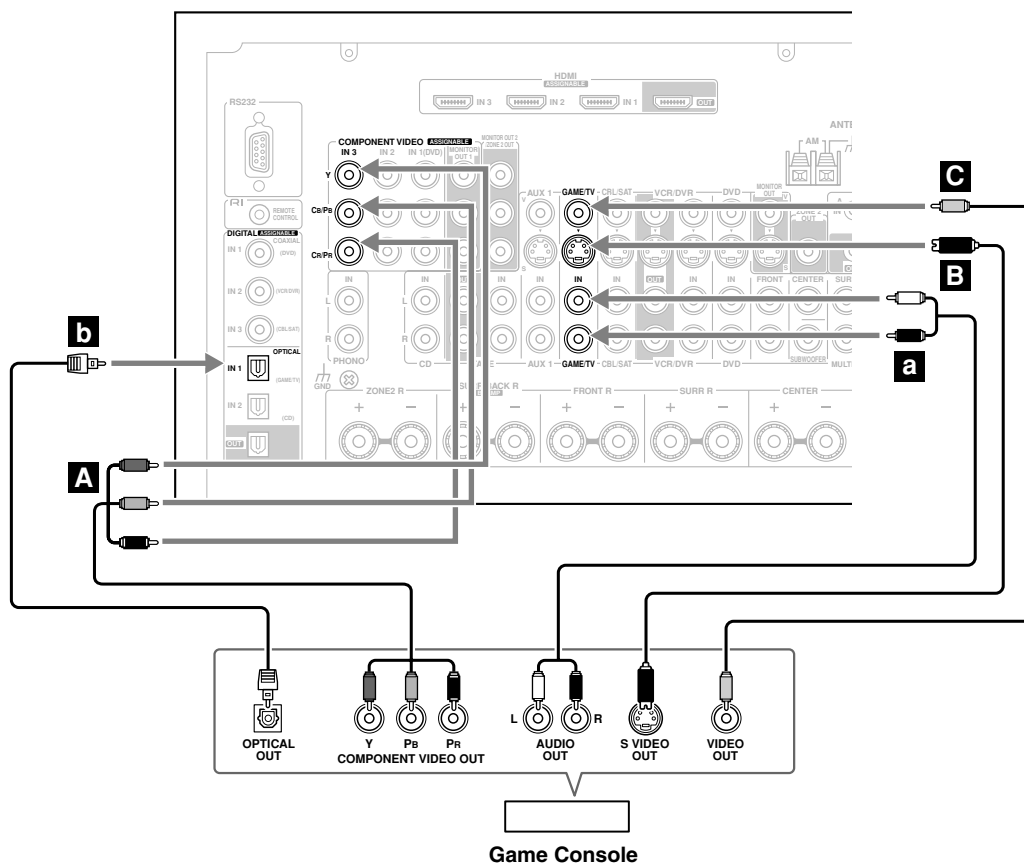

Connecting a Camcorder or Other AV Component

Step 1: Video Connection

Choose a video connection that matches your camcorder (**A** or **B**), and then make the connection.

Step 2: Audio Connection

Choose an audio connection that matches your camcorder (**a** or **b**), and then make the connection.

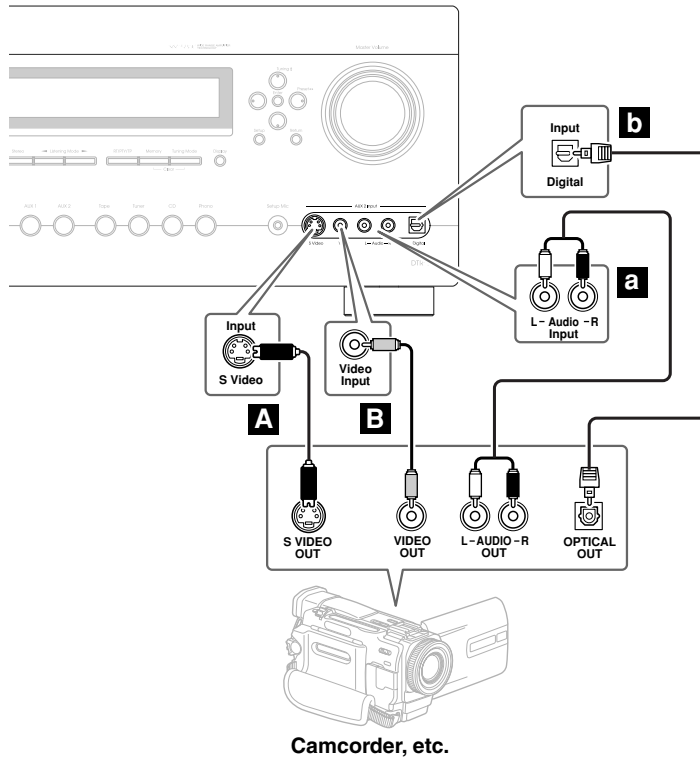

Connection	AV receiver	Signal flow	Camcorder
A	AUX 2 Input S Video	←	S-Video output
B	AUX 2 Input Video	←	Composite video output
a	AUX 2 Input L/R	←	Analog audio L/R output
b	AUX 2 Input Digital	←	Digital optical output

Connecting a CD Player

Step 1:

Choose a connection that matches your CD player **(a, b, or c)**, and then make the connection.

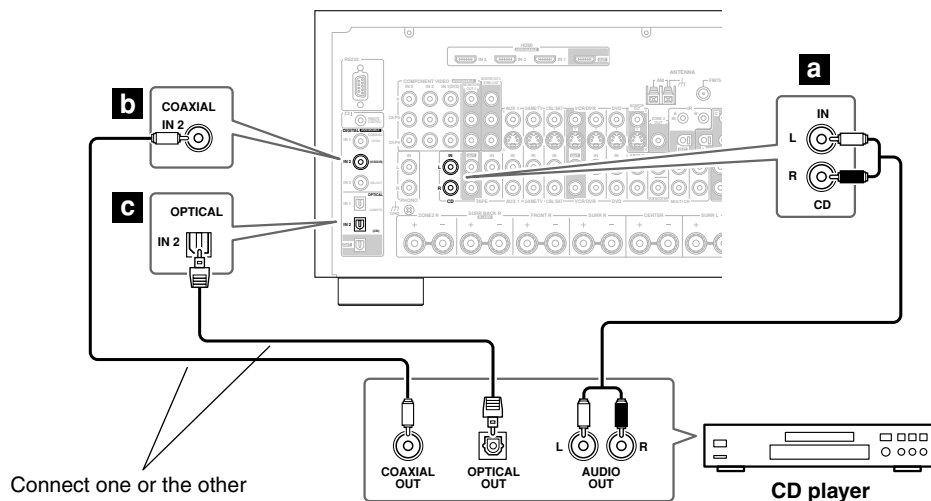

- With connection **a**, you can listen to and record audio from the CD player or listen in Zone 2 or Zone 3.
- To connect the CD player digitally, use connection **b** or **c**. (To record or listen in Zone 2 or Zone 3 as well, use **a** and **b**, or **a** and **c**.)

Connection	AV receiver	Signal flow	CD
a	CD IN L/R	←	Analog audio L/R output
b	DIGITAL COAXIAL IN 2	←	Digital coaxial output
c	DIGITAL OPTICAL IN 2	←	Digital optical output

Connecting a Turntable

The AV receiver's PHONO IN is designed for use with a moving magnet (MM) type cartridge.

Use an analog audio cable to connect the AV receiver's PHONO IN L/R jacks to the audio output on your turntable.

Notes:

- If your turntable has a ground wire, connect it to the AV receiver's GND screw. With some turntables, connecting the ground wire may produce an audible hum. If this happens, disconnect it.
- If your turntable has a moving coil (MC) type cartridge, you'll need a commercially available MC head amp or MC transformer. Connect your turntable to the head amp or transformer, and connect that to the AV receiver's PHONO IN L/R jacks.
- You can also use a phono equalizer to connect a turntable with an MC-type cartridge. See your phono equalizer's manual for details.

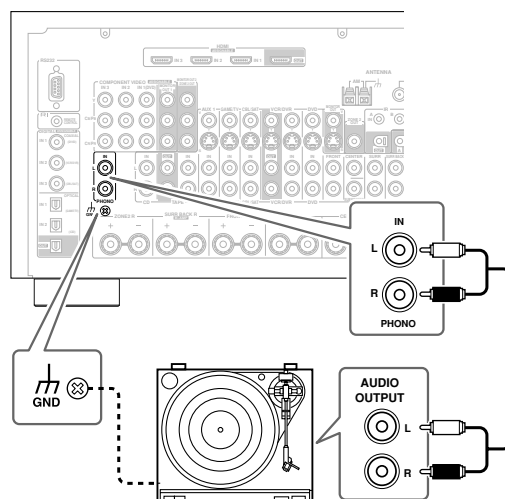

Connecting a Cassette, CDR, MiniDisc, or DAT Recorder

Step 1:

Choose a connection that matches your recorder (**a**, **b**, **c**, or **d**), and then make the connection.

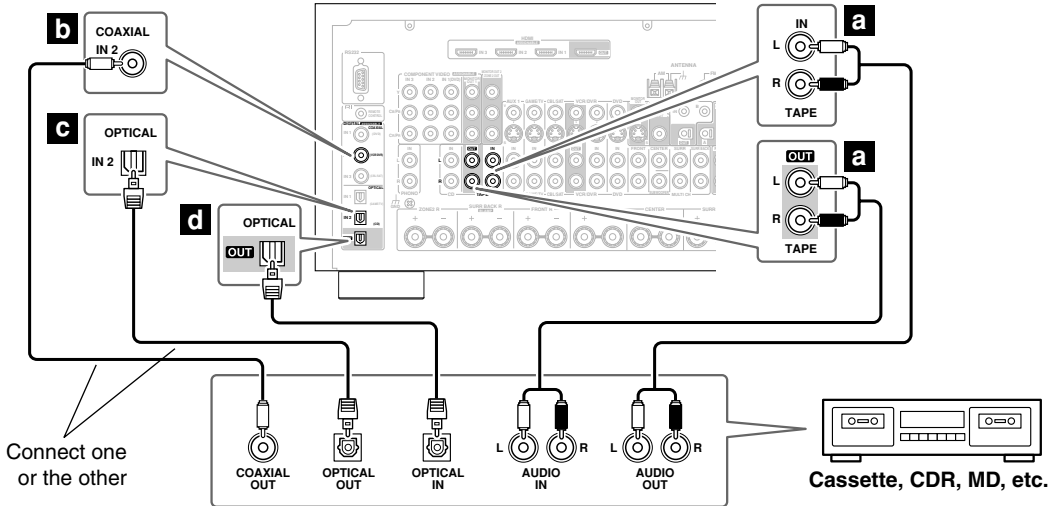

- With connection **a**, you can play and record or listen in Zone 2 or Zone 3.
- To connect the recorder digitally for playback, use connections **a** and **b**, or **a** and **c**.
- To connect the recorder digitally for recording, use connection **d**.

Connection	AV receiver	Signal flow	Cassette, CDR, MD, or DAT recorder
a	TAPE IN L/R TAPE OUT L/R	← ⇒	Analog audio L/R output Analog audio L/R input
b	DIGITAL COAXIAL IN 2	←	Digital coaxial output
c	DIGITAL OPTICAL IN 2	←	Digital optical output
d	DIGITAL OPTICAL OUT	⇒	Digital optical input

Connecting a Power Amplifier

If you want to use a more powerful power amplifier and use the AV receiver solely as a preamp, connect the amp to the PRE OUT jacks, and connect all speakers and the subwoofer to the power amplifier. If you have a powered subwoofer, connect it to the AV receiver's PRE OUT SUBWOOFER jack.

1. Subwoofer
2. Front left speaker
3. Center speaker
4. Front right speaker
5. Surround left speaker
6. Surround right speaker
7. Surround back left speaker
8. Surround back right speaker

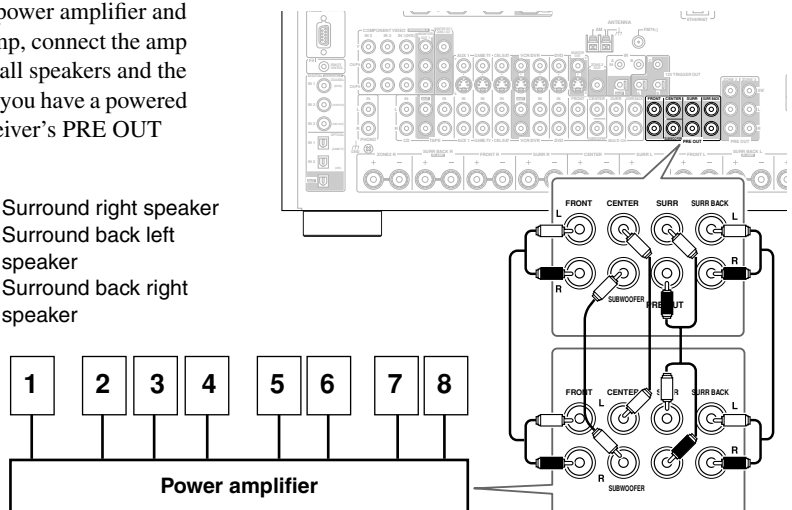

Connecting an RI Dock

■ If Your iPod Supports Video:

Connect your RI Dock's audio output jacks to the AV receiver's GAME/TV IN L/R jacks, and connect its video output jack to the AV receiver's GAME/TV IN V jack.

(Onkyo DS-A2 hookup shown below.)

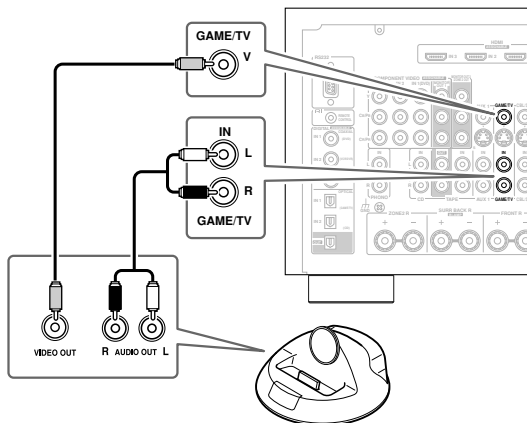

■ If Your iPod Doesn't Support Video:

Connect your RI Dock's audio output jacks to the AV receiver's GAME/TV IN L/R jacks. (Onkyo DS-A2 hookup shown below.)

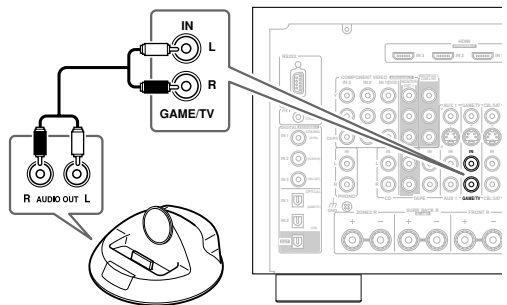

■ If you have an Onkyo DS-A1 RI Dock

- Connect its video output jack to the AV receiver's GAME/TV IN S jack.
- Enter the appropriate remote control code before using the AV receiver's remote controller for the first time (see page 119).

Notes:

- Connect the RI Dock to the AV receiver with an **RI** cable (see page 42).
- Set the RI Dock's RI MODE switch to HDD or HDD/DOCK.
- Set the AV receiver's Input Display to DOCK (see page 49).
- See the RI Dock's instruction manual for more information.

Connecting the Power Cords of Other Components (North American model only)

The AV receiver has AC outlets on its rear panel that can be used to connect the power cords of other components that you intend to use with the AV receiver. These components can then be left turned on so that they turn on and off as and when the AV receiver is set to On or Standby.

Caution:

- Make sure that the total capacity of the components that you connect to the AC OUTLETS does not exceed the stated capacity (e.g., TOTAL 120 W).

Notes:

- When the HDMI Control setting is set to Enable (page 109), the AC outlets are on all the time regardless of whether the AV receiver is set to On or Standby, or Ready mode in this case, so any components connected to them cannot be turned on or off automatically.
- Integra/Onkyo components connected via **RI** should be connected directly to a wall outlet, not an AC OUTLET on the AV receiver.

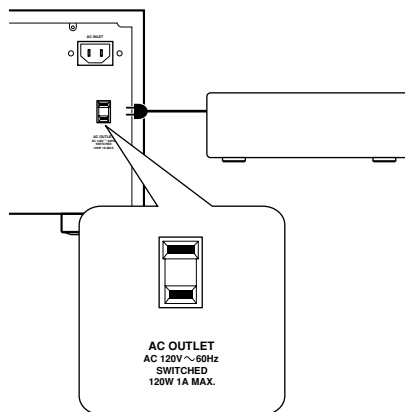

Connecting Integra/Onkyo **RI** Components

Step 1: Make sure that each Integra/Onkyo component is connected to the AV receiver with an analog audio cable (RCA).

Step 2: Make the necessary **RI** connections (see illustration below).

Step 3: If you're using an MD, CDR, or RI DOCK component, change the Input Display (see page 49).

With **RI** (Remote Interactive), you can use the following special functions:

Auto Power On/Standby

When you start playback on a component connected via **RI**, if the AV receiver is on Standby, it will automatically turn on and select that component as the input source. Similarly, when the AV receiver is set to Standby, all components connected via **RI** will also go on Standby. This function will not work with components that are connected to an AC OUTLET on the AV receiver.

Direct Change

When playback is started on a component connected via **RI**, the AV receiver automatically selects that component as the input source. If your DVD player is connected to the AV receiver's multichannel input, you'll need to press the [Audio Selector] button repeatedly and select Multich to hear all channels (see page 81), as the Direct Change **RI** function selects the DVD IN L/R jacks.

Remote Control

You can use the AV receiver's remote controller to control your other **RI**-capable Integra/Onkyo components. You must enter the appropriate remote control code first (see page 120). And remember to point the remote controller at the AV receiver and not the other component.

Notes:

- Use only **RI** cables for **RI** connections. **RI** cables are supplied with Integra/Onkyo players (DVD, CD, etc.).
- Some components have two **RI** jacks. You can connect either one to the AV receiver. The other jack is for connecting additional **RI**-capable components.
- Connect only Integra/Onkyo components to **RI** jacks. Connecting other manufacturer's components may cause a malfunction.
- Some components may not support all **RI** functions. Refer to the manuals supplied with your other Integra/Onkyo components.
- While Zone 2 or Zone 3 is on, the Auto Power On/Standby and Direct Change **RI** functions do not work.

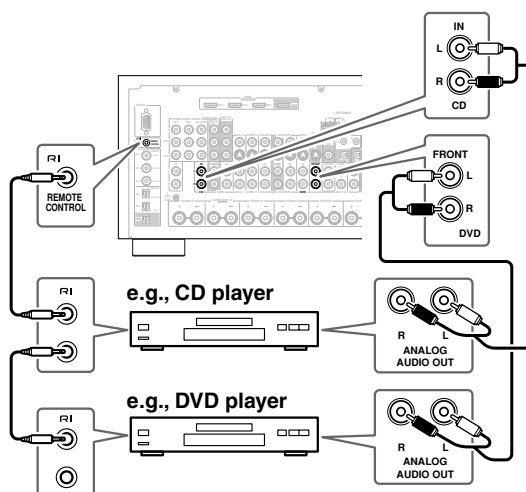

Connecting the Power Cord

- **Before connecting the power cord, connect all your speakers and AV components.**
- Connect the power cord to the AV receiver's AC INLET.
- Plug the other end of the power cord into a suitable wall outlet.
- Turning on the AV receiver may cause a momentary power surge that might interfere with other electrical equipment on the same circuit. If this is a problem, plug the AV receiver into a different branch circuit.

Turning On the AV Receiver

• North American model

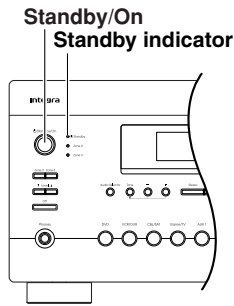

• Other models

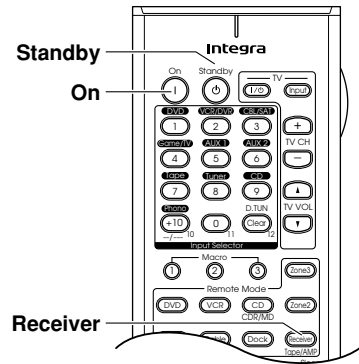
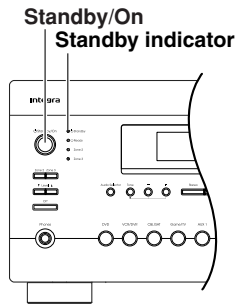

Turning On and Standby

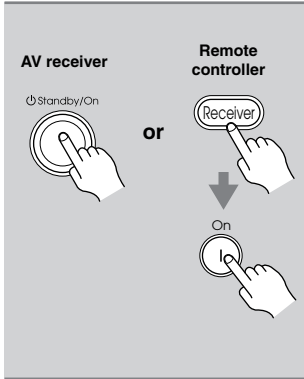

On the AV receiver, press the [Standby/On] button.

On the remote controller, press the [Receiver] Remote Mode button, followed by the [On] button.

The AV receiver comes on, the display lights up, and the Standby indicator goes off. Pressing the remote controller's [On] button again will turn on any components connected via **RI**.

To turn the AV receiver off, press the [Standby/On] button, or press the remote controller's [Standby] button. The AV receiver will enter Standby mode. To prevent any loud surprises the next time you turn on the AV receiver, turn down the volume before you turn it off.

Up and Running in a Few Easy Steps

To get your system up and running with the minimum of fuss, here's a few pointers to help you configure the AV receiver before you use it for the very first time. These settings only need to be made once.

■ **Do the automatic speaker setup—this is essential!**

See "Automatic Speaker Setup (Audyssey MultEQ XT)" on page 53. 

■ **Did you connect your TV to the HDMI OUT or COMPONENT VIDEO MONITOR OUT 1 or 2?**

If you did, see "HDMI Monitor Setup" on page 45. 

■ **Did you connect a component to an HDMI input, component video input, or digital audio input?**

If you did, see "HDMI Input Setup" on page 46, "Component Video Input Setup" on page 48, or "Digital Input Setup" on page 50 respectively.

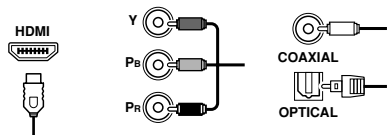

■ **Did you connect an Onkyo MD recorder, CD recorder, or RI Dock?**

If you did, see "Changing the Input Display" on page 49.

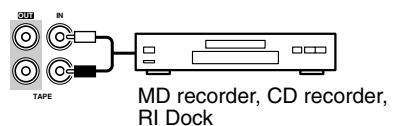

First Time Setup

This section explains the settings that you need to make before using the AV receiver for the very first time.

Speaker Settings

If you change these settings, you must run the automatic speaker setup again (see page 53).

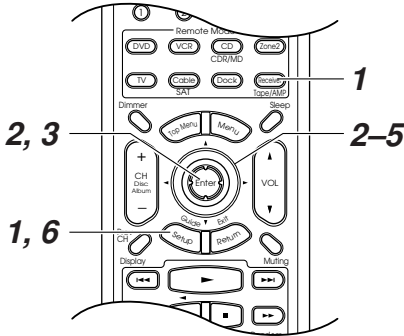

If the impedance of any speaker is 4 ohms or more but less than 6, set the Speaker Impedance to 4 ohms.

If you've connected your front speakers to the FRONT and SURR BACK terminal posts for bi-amping, you must change the Speaker Type setting. For hookup information, see "Bi-amping the Front Speakers" on page 23.

Notes:

- When bi-amping is used, the AV receiver is able to drive up to 5.1 speakers in the main room.
- Before you change these settings, turn down the volume.

1

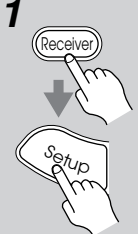

Press the [Receiver] button, followed by the [Setup] button.
The main menu appears onscreen.

2

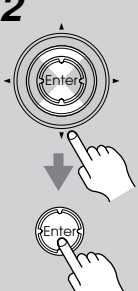

Use the Up and Down [▲]/[▼] buttons to select "2. Speaker Setup," and then press [Enter].
The Speaker Setup menu appears.

3

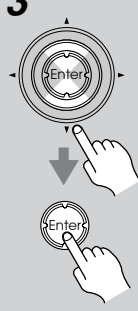

Use the Up and Down [▲]/[▼] buttons to select "1. Speaker Settings," and then press [Enter].
The Speaker Settings menu appears.

2-1. Speaker Settings

Speaker Impedance ◀ 6ohms ▶

Speakers Type Normal

4

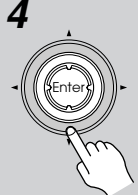

Use the Up and Down [▲]/[▼] buttons to select "Speaker Impedance," and use the Left and Right [◀]/[▶] buttons to select:

4 ohms: Select if the impedance of any speaker is 4 ohms or more but less than 6.

6 ohms: Select if the impedances of all speakers are between 6 and 16 ohms.

5



Use the Up and Down [▲]/[▼] buttons to select "Speaker Type," and use the Left and Right [◀]/[▶] buttons to select:

Normal: Select this if you've connected your front speakers normally.

Bi-Amp: Select this if you've connected your front speakers for bi-amped operation.

6



Press the [Setup] button.
Setup closes.

Note:

- This procedure can also be performed on the AV receiver by using its [Setup], [Enter], and arrow buttons.

HDMI Monitor Setup

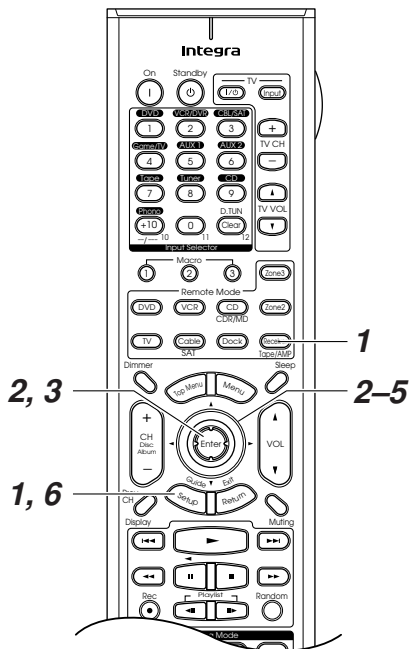

If you connect your TV to the COMPONENT VIDEO MONITOR OUT 1 or COMPONENT VIDEO MONITOR OUT 2/ZONE 2 OUT, set the HDMI Monitor setting to No so that the onscreen setup menus are displayed and composite video and S-Video sources are upconverted and output by the COMPONENT VIDEO MONITOR OUT 1 and COMPONENT VIDEO MONITOR OUT 2/ZONE 2 OUT.

If you connect your TV to the HDMI OUT, set the HDMI Monitor setting to Yes so that the onscreen setup menus are displayed and composite video, S-Video, and component video sources are upconverted and output by the HDMI OUT.



1 Press the [Receiver] button, followed by the [Setup] button. The main menu appears onscreen.

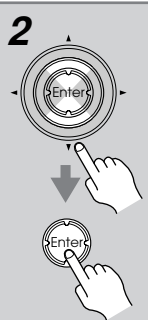

2 Use the Up and Down [▲]/[▼] buttons to select “1. Input/Output Assign,” and then press [Enter]. The Input/Output Assign menu appears.

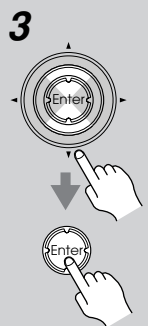

3 Use the Up and Down [▲]/[▼] buttons to select “1. Monitor Out,” and then press [Enter]. The Monitor Out menu appears.

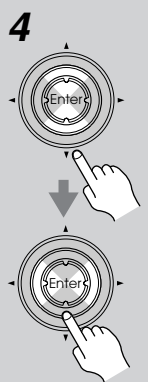
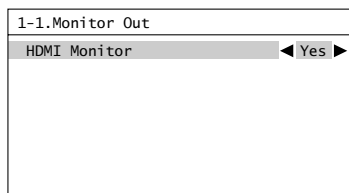

4 Use the Up and Down [▲]/[▼] buttons to select “HDMI Monitor,” and use the Left and Right [◀]/[▶] buttons to select:

- No:** Select this if your TV is connected to the COMPONENT VIDEO MONITOR OUT 1, COMPONENT VIDEO MONITOR OUT 2/ZONE 2 OUT, S MONITOR OUT, or V MONITOR OUT.
- Yes:** Select this if your TV is connected to the HDMI OUT.

Note:

- When Yes is selected, the onscreen setup menus are output by only the HDMI OUT. If you’re not using the HDMI OUT and select Yes by mistake and the menus disappear, turn off your components, connect the AV receiver to your TV with a composite video or S-Video cable, and then change this setting back to No.

5

Use the Up and Down [▲]/[▼] buttons to select “Monitor Out2,” and use the Left and Right [◀]/[▶] buttons to select:

Monitor: Select this if you’ve connected the COMPONENT VIDEO MONITOR OUT 2/ZONE 2 OUT to a TV or other component in your main room.

Zone 2: Select this if you’ve connected the COMPONENT VIDEO MONITOR OUT 2/ZONE 2 OUT to a TV in Zone 2.

When Monitor is selected, the COMPONENT VIDEO MONITOR OUT 2/ZONE 2 OUT outputs the same video as the COMPONENT VIDEO MONITOR OUT 1.

Notes:

- See page 27 for charts showing how the HDMI Monitor setting affects the video signal flow through the AV receiver.
- This procedure can also be performed on the AV receiver by using its [Setup], [Enter], and arrow buttons.

HDMI Input Setup

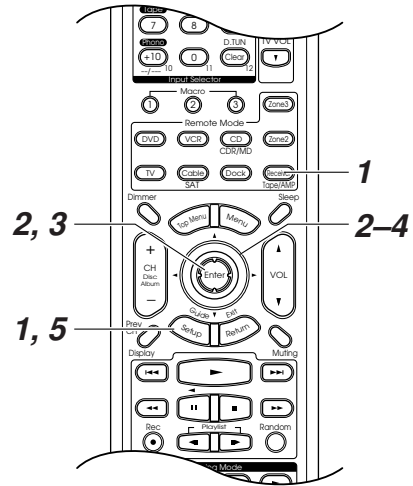



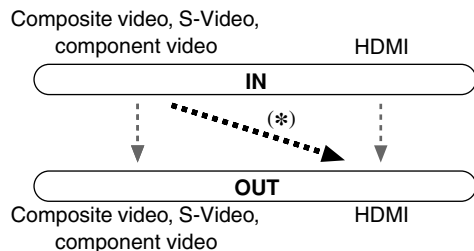

If you connect a video component to an HDMI IN, you must assign that input to an input selector. For example, if you connect your DVD player to HDMI IN 1, you must assign HDMI IN 1 to the DVD input selector.

By default, none of the HDMI inputs are assigned. The following input selectors can be assigned: DVD, VCR/DVR, CBL/SAT, GAME/TV, AUX 1, AUX 2, TAPE, CD, PHONO.

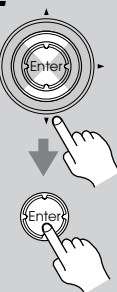
If you’ve connected your TV to the AV receiver with an HDMI cable, you can set the AV receiver so that composite video, S-Video, and component video sources are upconverted (*) and output by the HDMI OUT. You can set this for each input selector by selecting the “- - -” option.



<p>1</p> 	<p>Press the [Receiver] button, followed by the [Setup] button. The main menu appears onscreen.</p>												
<p>2</p> 	<p>Use the Up and Down [▲]/[▼] buttons to select “1. Input/Output Assign,” and then press [Enter]. The Input/Output Assign menu appears.</p>												
<p>3</p> 	<p>Use the Up and Down [▲]/[▼] buttons to select “2. HDMI Input,” and then press [Enter]. The HDMI Input menu appears.</p> <div data-bbox="281 917 628 1107" style="border: 1px solid black; padding: 5px;"> <p>1-2. HDMI Input</p> <table border="0"> <tr> <td>DVD</td> <td>◀ --- ▶</td> </tr> <tr> <td>VCR/DVR</td> <td>---</td> </tr> <tr> <td>CBL/SAT</td> <td>---</td> </tr> <tr> <td>GAME/TV</td> <td>---</td> </tr> <tr> <td>AUX1</td> <td>---</td> </tr> <tr> <td>AUX2</td> <td>---</td> </tr> </table> </div>	DVD	◀ --- ▶	VCR/DVR	---	CBL/SAT	---	GAME/TV	---	AUX1	---	AUX2	---
DVD	◀ --- ▶												
VCR/DVR	---												
CBL/SAT	---												
GAME/TV	---												
AUX1	---												
AUX2	---												
<p>4</p> 	<p>Use the Up and Down [▲]/[▼] buttons to select an input selector, and use the Left and Right [◀]/[▶] buttons to select:</p> <p>IN1: Select if the video component is connected to HDMI IN 1.</p> <p>IN2: Select if the video component is connected to HDMI IN 2.</p> <p>IN3: Select if the video component is connected to HDMI IN 3.</p> <p>- - -: Select this to upconvert and output composite video, S-Video, and component video sources from the HDMI OUT.</p>												
<p>5</p> 	<p>Press the [Setup] button. Setup closes.</p>												

Notes:

- Each HDMI IN cannot be assigned to more than one input selector.
- **For composite video, S-Video, and component video upconversion for the HDMI OUT, the HDMI Monitor setting must be set to Yes (see page 45).** See page 27 for more information on video signal flow and upconversion.
- When an HDMI IN is assigned to an input selector as explained here, the digital audio input for that input selector is automatically set to the same HDMI IN. See “Digital Input Setup” on page 50.
- This procedure can also be performed on the AV receiver by using its [Setup], [Enter], and arrow buttons.

Component Video Input Setup

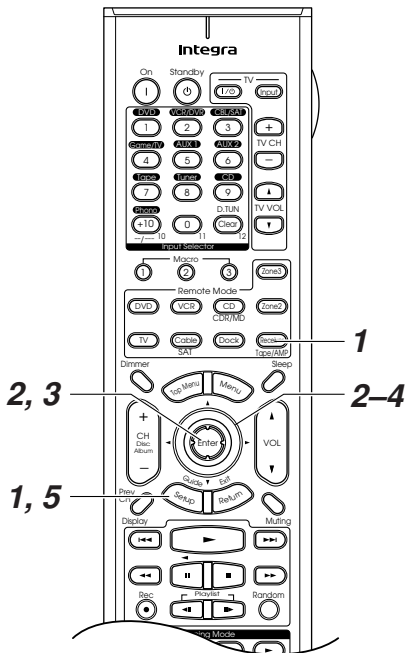

If you connect a video component to a COMPONENT VIDEO IN, you must assign that input to an input selector. For example, if you connect your DVD player to COMPONENT VIDEO IN 3, you must assign COMPONENT VIDEO IN 3 to the DVD input selector.

By default, the DVD input selector is assigned to COMPONENT VIDEO IN 1, and all of the other input selectors (i.e., VCR/DVR, CBL/SAT, GAME/TV, AUX 1, AUX 2, TAPE, CD, PHONO) are assigned to the “- - -” option.

If you’ve connected your TV to the AV receiver with a component video cable, you can set the AV receiver so that composite video and S-Video sources are upconverted (*) and output by the COMPONENT VIDEO MONITOR OUT 1 or 2. You can set this for each input selector by selecting the “- - -” option.

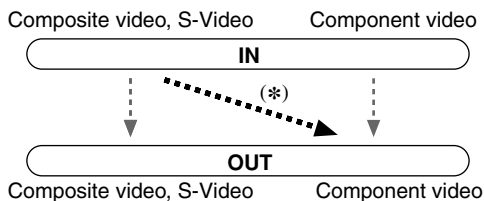

1 Press the [Receiver] button, followed by the [Setup] button. The main menu appears onscreen.

2 Use the Up and Down [▲]/[▼] buttons to select “1. Input/Output Assign,” and then press [Enter]. The Input/Output Assign menu appears.

3 Use the Up and Down [▲]/[▼] buttons to select “3. Component Video Input,” and then press [Enter]. The Component Video Input menu appears.

1-3. Component Video Input	
DVD	◀ IN1 ▶
VCR/DVR	---
CBL/SAT	---
GAME/TV	---
AUX1	---
AUX2	---

4 Use the Up and Down [▲]/[▼] buttons to select an input selector, and use the Left and Right [◀]/[▶] buttons to select:

- IN1:** Select if the video component is connected to COMPONENT VIDEO IN 1.
- IN2:** Select if the video component is connected to COMPONENT VIDEO IN 2.
- IN3:** Select if the video component is connected to COMPONENT VIDEO IN 3.
- : Select to output composite video and S-Video sources from the COMPONENT VIDEO OUT.

5

Press the [Setup] button.

Setup closes.



Notes:

- For composite video and S-Video upconversion for the COMPONENT VIDEO MONITOR OUT 1 or 2, the HDMI Monitor setting must be set to No (see page 45). See page 27 for more information on video signal flow and upconversion.
- This procedure can also be performed on the AV receiver by using its [Setup], [Enter], and arrow buttons.

Changing the Input Display

If you connect an **RI**-capable Onkyo MiniDisc recorder, CD recorder, or RI Dock to the TAPE IN/OUT jacks, or connect an RI Dock to the GAME/TV jacks, for **RI** to work properly, you must change this setting.

This setting can only be changed on the AV receiver.

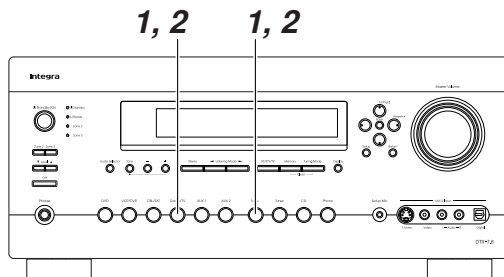

1



or
Game/TV



Press the [Tape] or [Game/TV] input selector button so that “TAPE” or “GAME/TV” appears on the display.

TAPE

GAME/TV

2



or
Game/TV



Press and hold down the [Tape] or [Game/TV] input selector button (about 3 seconds) to change the setting.

Repeat this step to select MD, CDR, or DOCK.

For the Tape input selector, the setting changes in this order:

TAPE → MD → CDR
 ↑ DOCK ↓

For the Game/TV input selector, the setting changes in this order:

GAME/TV ↔ DOCK

Note:

- DOCK can be selected for the Tape input selector or Game/TV input selector, but not both at the same time.

Digital Input Setup

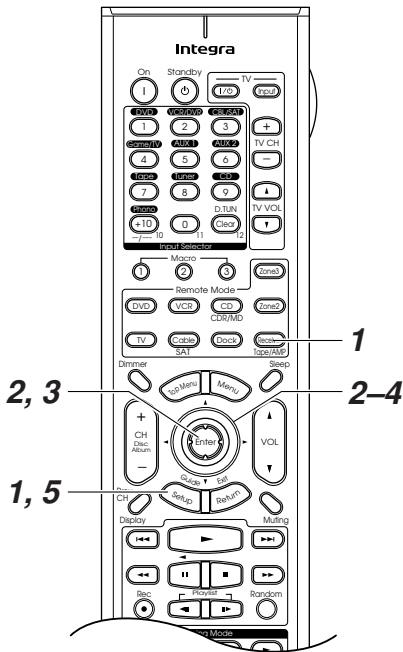

If you connect a component to a digital audio input, you must assign that input to an input selector. For example, if you connect your CD player to OPTICAL IN 2, you must assign OPTICAL IN 2 to the CD input selector.

These are the default assignments.

Input selector	Audio input
DVD	COAX1
VCR/DVR	COAX2
CBL/SAT	COAX3
GAME/TV	OPT1
AUX 1	---
AUX 2	FRONT (Fixed)
TAPE	---
TUNER	---
CD	OPT2
PHONO	---

1 Press the [Receiver] button, followed by the [Setup] button. The main menu appears onscreen.

2 Use the Up and Down [▲]/[▼] buttons to select “1. Input/Output Assign,” and then press [Enter]. The Input/Output Assign menu appears.

3 Use the Up and Down [▲]/[▼] buttons to select “4. Digital Input,” and then press [Enter]. The Digital Input menu appears.

1-4. Digital Input	
DVD	◀ COAX1 ▶
VCR/DVR	COAX2
CBL/SAT	COAX3
GAME/TV	OPT1
AUX1	---
AUX2	FRONT
TAPE	---
TUNER	---
CD	OPT2
PHONO	---

4 Use the Up and Down [▲]/[▼] buttons to select an input selector, and then use the Left and Right [◀]/[▶] buttons to select:

- COAX1:** Select if the component is connected to DIGITAL COAXIAL IN 1.
- COAX2:** Select if the component is connected to DIGITAL COAXIAL IN 2.
- COAX3:** Select if the component is connected to DIGITAL COAXIAL IN 3.
- OPT1:** Select if the component is connected to DIGITAL OPTICAL IN 1.
- OPT2:** Select if the component is connected to DIGITAL OPTICAL IN 2.
- : Select if the component is connected to an analog input.

5



Press the [Setup] button.

Setup closes.

Notes:

- Only FRONT can be assigned to the AUX 2 input selector.
- The TUNER input selector cannot be assigned and is fixed at the “- - -” option.
- When an HDMI IN is assigned to an input selector in “HDMI Video Setup” on page 46, this input assignment is automatically set to the same HDMI IN. And in addition to the usual inputs (e.g., COAX1, COAX2, etc.), you can also select HDMI inputs.
- This procedure can also be performed on the AV receiver by using its [Setup], [Enter], and arrow buttons.

Analog Input Setup

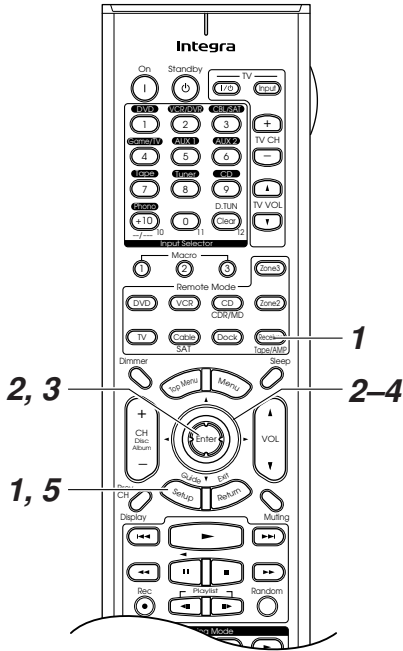

3 Use the Up and Down [▲]/[▼] buttons to select “5. Analog Input,” and then press [Enter]. The Analog Input menu appears.

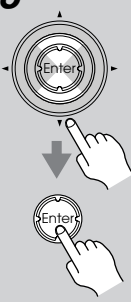

1-5. Analog Input	
Multich	◀ DVD ▶

4 Use the Left and Right [◀]/[▶] buttons to select an input selector.

You can assign the multichannel input to the following input selectors: DVD, VCR/DVR, CBL/SAT, GAME/TV, AUX 1, AUX 2, TAPE, CD, or PHONO.



5 Press the [Setup] button. Setup closes.



If you connect a component to the AV receiver’s analog multichannel input, you must assign that input to an input selector. For example, if you connect your DVD player to the MULTI CH input, you must assign it to the DVD input selector.

Notes:

- To listen to the component connected to the multichannel input, press the [Audio Selector] button repeatedly to select Multich (see page 81).
- This procedure can also be performed on the AV receiver by using its [Setup], [Enter], and arrow buttons.

1 Press the [Receiver] button, followed by the [Setup] button. The main menu appears onscreen.

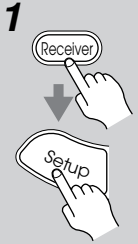

2 Use the Up and Down [▲]/[▼] buttons to select “1. Input/Output Assign,” and then press [Enter]. The Input/Output Assign menu appears.



Automatic Speaker Setup (Audyssey MultEQ XT)

With the supplied speaker setup microphone, Audyssey MultEQ XT can measure the number of speakers connected, their sizes, crossover frequencies, and distances from the listening position and calculate the optimal speaker settings for you automatically.

Before using this function, connect and position all of your speakers.

Measurement Positions

To create a listening environment in which several people can enjoy your home theater simultaneously, Audyssey MultEQ XT takes measurements at up to eight positions within the listening area.

■ 1st measurement position

This is the center position of your listening area, or the listening position if there's only one listener.

■ 2nd–8th measurement positions

These are the other listening positions (i.e., the places where the other listeners will sit). You can measure up to eight positions.

The following examples show some typical home theater seating arrangements. Choose the one that best matches yours, and position the microphone accordingly when prompted.

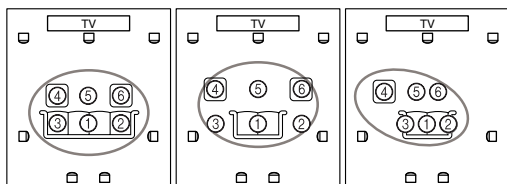
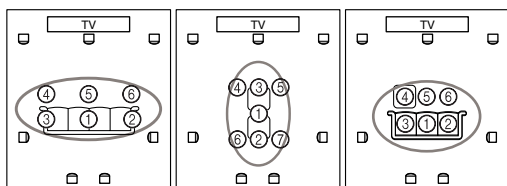
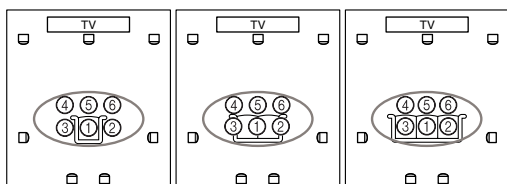

- : Listening area
- : Listening position

Using Audyssey MultEQ XT

Notes:

- If any of your speakers is 4 ohms, change the Speaker Impedance setting before running the automatic speaker setup (see page 44).
- If the AV receiver is muted, it will be unmuted automatically when the automatic speaker setup starts.
- Automatic speaker setup cannot be performed while a pair of headphones is connected.
- It takes about 15 minutes to complete the automatic speaker setup for three positions. Total measurement time varies depending on the number of positions and speakers.
- Do not disconnect the speaker setup microphone during the automatic speaker setup, unless you want to cancel the setup.
- Do not connect or disconnect any speakers during the automatic speaker setup.

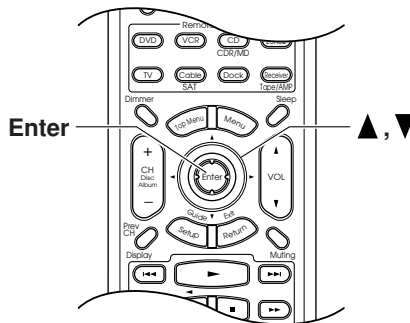
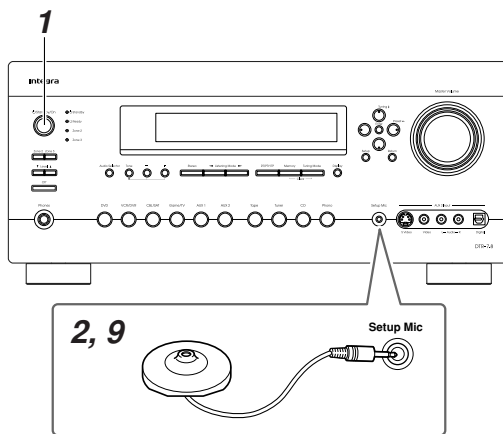

1 Turn on the AV receiver and the connected TV.
On the TV, select the input to which the AV receiver is connected.

2 Place the setup microphone at the 1st measurement position, and connect it to the Setup Mic jack.

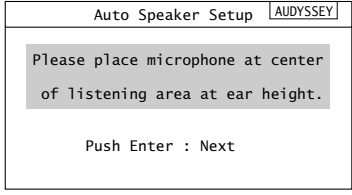
Notes:

- Make sure the microphone is horizontal.
- If there's an obstacle between the microphone and any speaker, the automatic setup will not work correctly. Set up the room as you would when enjoying a DVD movie.
- Positioning the microphone close to where your ears would normally be will provide the best results. You can set the height of the microphone by using a tripod or level table.

3 Press [Enter].



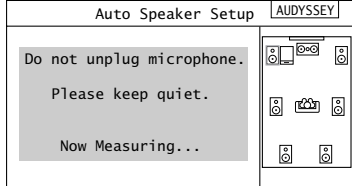

A test tone is output by each speaker in turn, as Audyssey MultEQ XT determines which speakers are connected. This takes a few minutes.

Note:

- If any extraneous noise is picked up by the microphone, the automatic setup may not work correctly, so keep quiet.

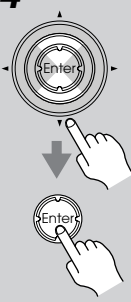
4 The speaker detect results appear.

“Yes” means that the speaker was detected. “No” means that no speaker was detected.

If you agree with the results, use the Up and Down [▲]/[▼] buttons to select Next, and then press [Enter].

The options are:

- Next:** Proceed to the next step.
- Retry:** Return to step 2 and try again.
- Cancel:** Cancel the automatic speaker setup.

5 The following screen appears.

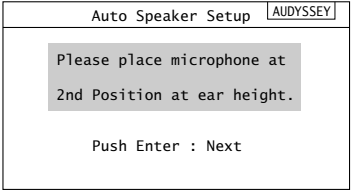

Place the setup microphone at the next position (see page 53), and then press [Enter].

Audyssey MultEQ XT performs more measurements. This takes a few minutes.

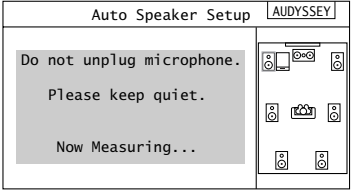

6 When prompted, place the setup microphone at the next position, and repeat step 5.

7

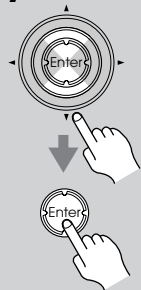

After the 3rd or 7th measurement, the following screen appears.

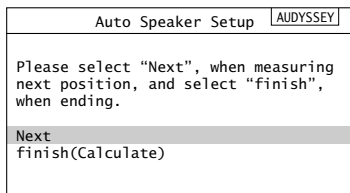

Use the Up and Down [▲]/[▼] buttons to select an option, and then press [Enter].

Next: Select this if you want to measure another listening position. After the 8th measurement has been taken, the procedure automatically proceeds to step 8.

Finish (Calculate): Select this if you don't want to measure any more listening positions and are ready to calculate the results, then go to step 8.

8

When the measurements are complete, the following screen appears.

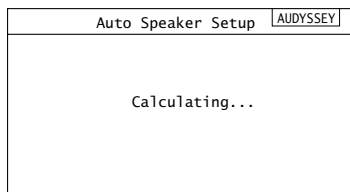

9

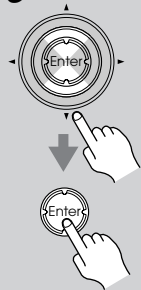

When the calculations are complete, the following screen appears.

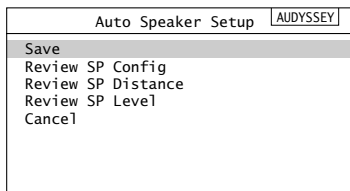

Use the Up and Down [▲]/[▼] buttons to select an option, and then press [Enter].

Save: Save the calculated settings and exit the automatic speaker setup.

Review SP Config: Review the speaker configuration settings (see “Reviewing the Results” on page 57).

Review SP Distance: Review the speaker distance settings (see “Reviewing the Results” on page 57).

Review SP Level: Review the speaker level settings (see “Reviewing the Results” on page 57).

Cancel: Cancel the automatic speaker setup.

10

If you selected “Save,” the results are saved, and the following screen appears.

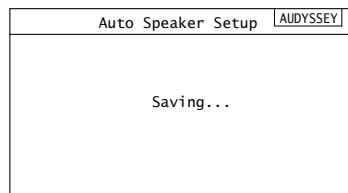

11

Disconnect the setup microphone.

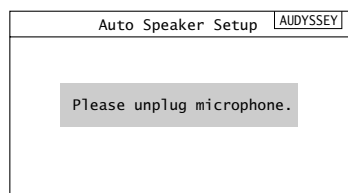

Notes:

- When the automatic speaker setup is complete, the Equalizer Settings (page 101) will be set to Audyssey.
- You can cancel the automatic speaker setup at any point in the procedure simply by disconnecting the setup microphone.

Error Messages

During the automatic speaker setup, one of the following error messages may appear:

Ambient noise is too high

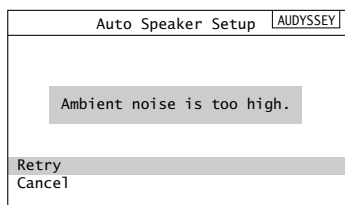

This message appears if there's too much background noise and the measurements cannot be performed properly. Remove the source of the noise and try again, or cancel the automatic speaker setup.

❑ Speaker Detect Error

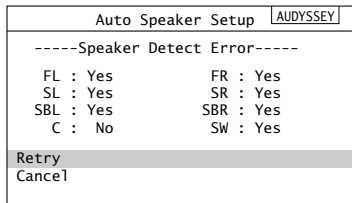

This message appears if a speaker is not detected. “Yes” means that a speaker was detected. “No” means that no speaker was detected. Check your speaker connections and retry, or cancel the automatic speaker setup.

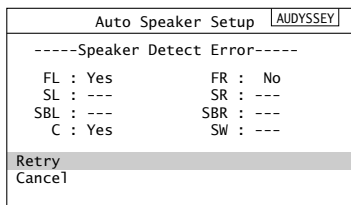

One of the front speakers has not been detected.

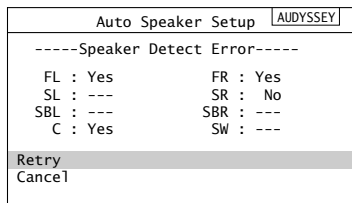

One of the surround speakers has not been detected.

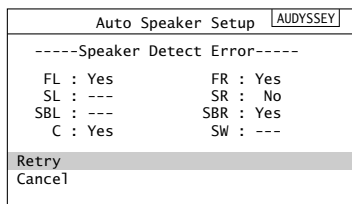

The surround back speakers have been detected but the surround speakers haven't.

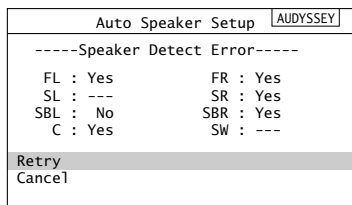

The right surround back speaker has been detected but the left surround back speaker hasn't.

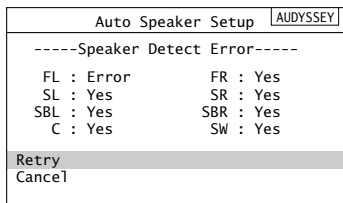

There is a problem with a speaker. The speaker may be broken.

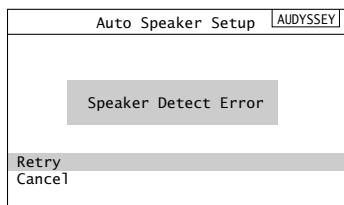

A different number of speakers has been detected.

❑ Writing Error

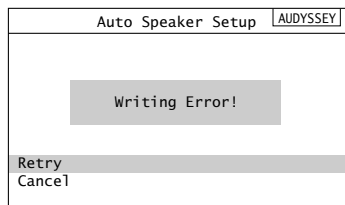

This message appears if saving fails. Try saving again, or cancel the automatic speaker setup.

If this message appears repeatedly, the AV receiver may be malfunctioning and you should contact the dealer from whom you purchased this unit.

Reviewing the Results

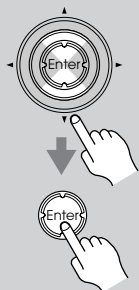

Use the Up and Down [▲]/[▼] buttons to select the settings that you want to review, and then press [Enter].

Auto Speaker Setup		AUDYSSEY
Save		
Review SP Config		
Review SP Distance		
Review SP Level		
Cancel		

The options are:

Review SP Config

Review the speaker configuration settings.

Auto Speaker Setup		AUDYSSEY
Review SP Config		
Subwoofer	:	Yes
Front	:	Full Band
Center	:	80Hz
Surround	:	100Hz
Surr Back	:	150Hz
Surr Back Ch	:	2ch

Review SP Distance

Review the speaker distance settings.

Auto Speaker Setup		AUDYSSEY
Review SP Distance		
Left	:	15ft
Center	:	15ft
Right	:	15ft
Surr Right	:	7ft
Surr Back R	:	7ft
Surr Back L	:	7ft
Surr Left	:	7ft
Subwoofer	:	15ft

Review SP Level

Review the speaker level settings.

Auto Speaker Setup		AUDYSSEY
Review SP Level		
Left	:	+12dB
Center	:	0dB
Right	:	-12dB
Surr Right	:	+3dB
Surr Back R	:	+4dB
Surr Back L	:	-6dB
Surr Left	:	-3dB
Subwoofer	:	0dB

Press [Return] to return to the previous screen.

Changing the Speaker Settings Manually

In some cases, the measurements taken by the automatic speaker setup may not provide usable results. If running the speaker setup a second time doesn't help, you'll have to set the speaker settings manually (see pages 96–101).

Notes:

- For THX-certified speakers, the 80 Hz (THX) crossover frequency is recommended. If you use the automatic speaker setup, you'll need to manually select 80 Hz (THX) for each THX-certified speaker (see page 96).
- Because of the complexities of low-frequency sounds and the way they interact with a room, THX recommends setting the subwoofer level and distance manually.

Using a Powered Subwoofer

If you're using a powered subwoofer, as it outputs very low-frequency sound and its position is usually low down, it may not be detected by the automatic speaker setup. In this case, increase the subwoofer's volume, select its highest crossover frequency, and then try running the automatic speaker setup again. Note that if the volume is set too high and the sound distorts, it may not be detected, so use an appropriate volume level. If the subwoofer has a low-pass filter switch, set it to Off or Direct. Refer to your subwoofer's instruction manual for details.

**TV Format Setup
(not North American models)**

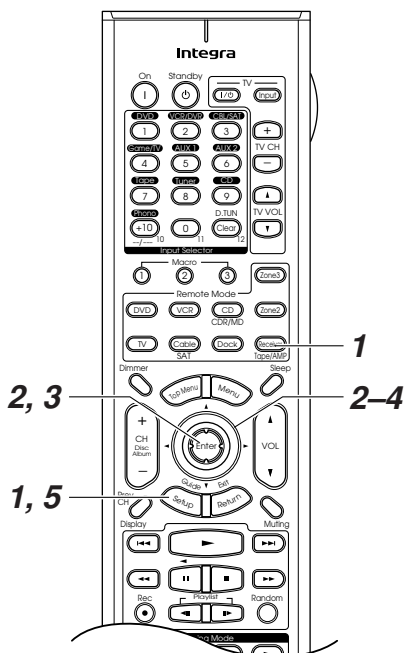

For the onscreen setup menus to display properly, you must specify the TV system used in your area.

1 Press the [Receiver] button, followed by the [Setup] button. The main menu appears onscreen.

2 Use the Up and Down [▲]/[▼] buttons to select “6. Miscellaneous,” and then press [Enter]. The Miscellaneous menu appears.

3 Use the Up and Down [▲]/[▼] buttons to select “2. OSD Setup,” and then press [Enter]. The OSD Setup menu appears.

6-2.OSD Setup	
Immediate Display	◀ On ▶
Monitor Type	4:3
Display Position	Bottom
TV Format	Auto

4 Use the Up and Down [▲]/[▼] buttons to select “TV Format,” and then use the Left and Right [◀]/[▶] buttons to select:

Auto: Select this to have the AV receiver automatically detect the TV system from the video input signals.

NTSC: Select if the TV system in your area is NTSC.

PAL: Select if the TV system in your area is PAL.

5 Press the [Setup] button. Setup closes.

Note:

- This procedure can also be performed on the AV receiver by using its [Setup], [Enter], and arrow buttons.

**AM Frequency Step Setup
(on some models)**

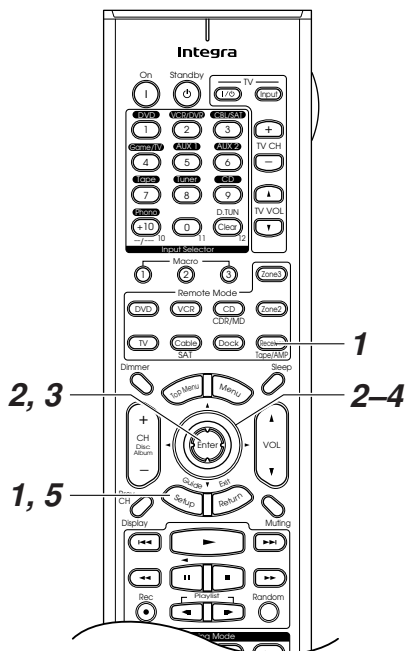

For AM tuning to work properly, you must specify the AM frequency step used in your area. Note that when this setting is changed, all radio presets are deleted.

1 Press the [Receiver] button, followed by the [Setup] button. The main menu appears onscreen.

2 Use the Up and Down [▲]/[▼] buttons to select “7. Hardware Setup,” and then press [Enter]. The Hardware Setup menu appears.

3 Use the Up and Down [▲]/[▼] buttons to select “3. Tuner,” and then press [Enter]. The Tuner menu appears.

7-3. Tuner

AM Freq Step ◀ 9kHz ▶

4 Use the Up and Down [▲]/[▼] buttons to select “AM Freq. Step,” and then use the Left and Right [◀]/[▶] buttons to select:

- 10 kHz:** Select if 10 kHz steps are used in your area.
- 9 kHz:** Select if 9 kHz steps are used in your area.

5 Press the [Setup] button. Setup closes.

Note:

- This procedure can also be performed on the AV receiver by using its [Setup], [Enter], and arrow buttons.

Playing Your AV Components

Basic AV Receiver Operation

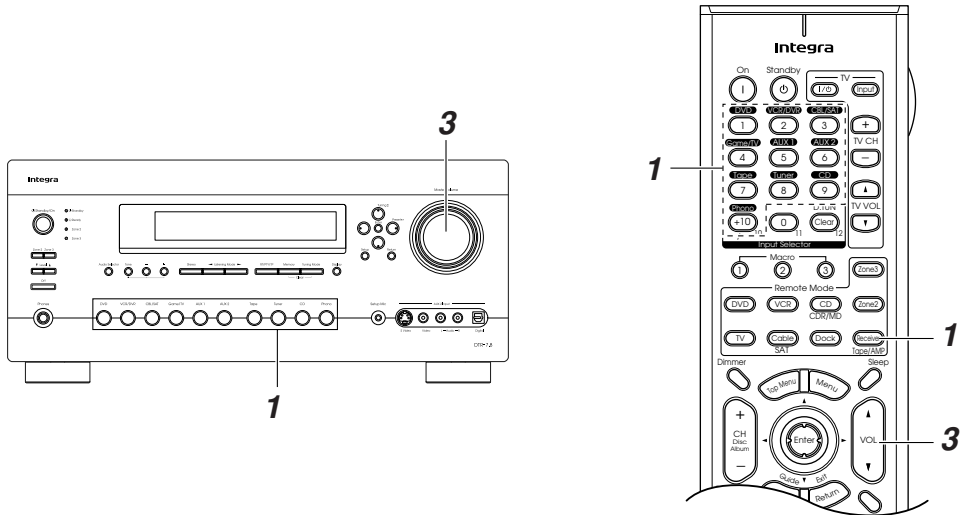

1

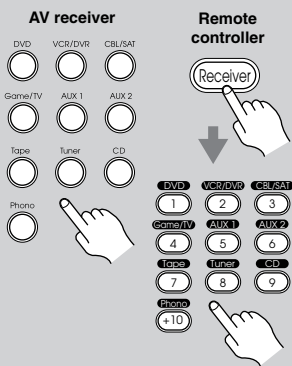

Use the AV receiver's input selector buttons to select an input source.

To select an input source with the remote controller, press its [Receiver] Remote Mode button, and then use its Input Selector buttons.

2

Start playback on the source component.

To watch a DVD or other video source, on your TV, select the video input that's connected to the AV receiver's COMPONENT VIDEO MONITOR OUT 1, COMPONENT VIDEO MONITOR OUT 2/ZONE 2 OUT, HDMI OUT, or MONITOR OUT. On some DVD players, you may need to change the digital or HDMI audio output settings.

3

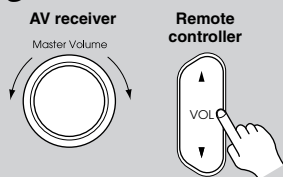

To adjust the volume, use the Master Volume control or the remote controller's [VOL] button.

Since the AV receiver is designed for home theaters, it has a wide volume range for precise adjustment. The volume can be set to $-\infty$ dB, -81.5 dB, -81.0 dB through $+18.0$ dB.

4

Select a listening mode and enjoy!

See "Using the Listening Modes" on page 82.

Listening to the Radio

Listening to AM/FM Stations

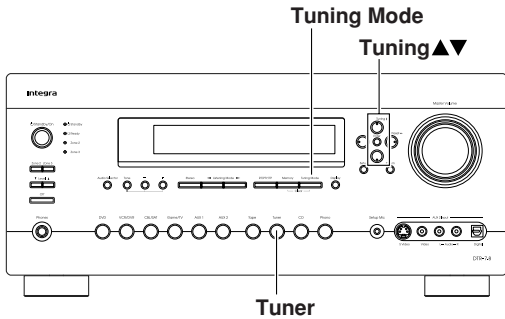

With the built-in tuner, you can enjoy AM and FM radio stations and store your favorite stations as presets for easy selection.



Use the [Tuner] input selector button to select AM or FM.

In this example, FM has been selected.

Band	Frequency
FM	87.5 MHz

(Actual display depends on country.)

Manual Tuning Mode

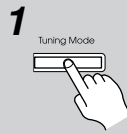

1 Press the [Tuning Mode] button so that the AUTO indicator disappears from the display.



2 Press and hold the Tuning Up or Down [▲]/[▼] button.

The frequency stops changing when you release the button.

Press the button repeatedly to change the frequency one step at a time.

The North American model changes FM frequency in 0.2 MHz steps, 10 kHz steps for AM. For other models it's 0.05 MHz steps for FM and 9 kHz steps for AM.

In Manual Tuning mode, FM stations will be in mono.

Tuning into Weak FM Stereo Stations

If the signal from a stereo FM station is weak, it may be impossible to get good reception. In this case, switch to Manual Tuning mode and listen to the station in mono.

Tuning into AM/FM Radio Stations

Auto Tuning Mode

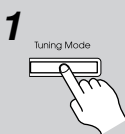

1 Press the [Tuning Mode] button so that the AUTO indicator appears on the display.



2 Press the Tuning Up or Down [▲]/[▼] button.

Searching stops when a station is found.

When tuned into a station, the TUNED indicator appears. When tuned into a stereo FM station, the FM STEREO indicator also appears.

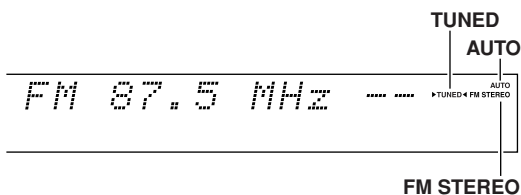

Listening to the Radio—Continued

■ Tuning into Stations by Frequency

You can tune into AM and FM stations directly by entering the appropriate frequency.

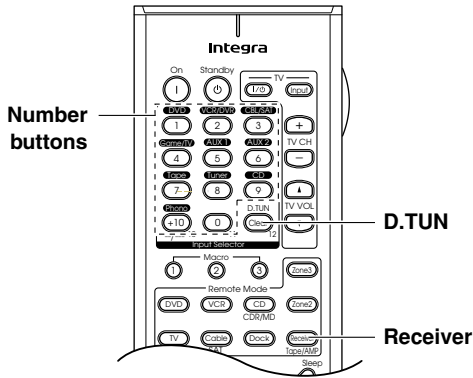

Displaying AM/FM Radio Information

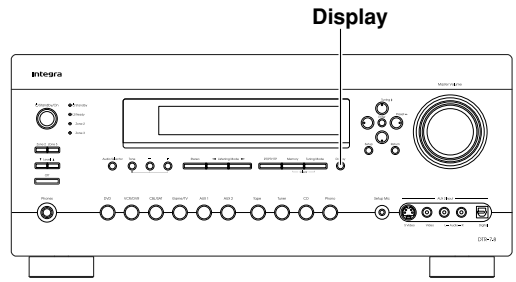

Display

Press the [Display] button to display the available information.

1

Press the [Receiver] button, followed by the [D.TUN] button.
The [Receiver] button flashes.

(Actual display depends on country.)

2

Within 8 seconds, use the number buttons to enter the frequency of the radio station.
For example, to tune to 87.5 (FM), press 8, 7, 5.

Note:
While the [Receiver] button is flashing, you cannot select another input source with the remote controller.

Band	Frequency	Preset #
FM	88.1 MHz	1
Stereo		

Listening mode

Note:

- When you select a preset with a custom name (see page 104), its name is displayed instead of the band and frequency.

Using RDS (not North American model)

RDS only works in areas where RDS broadcasts are available. When tuned to an RDS station, the RDS indicator appears.

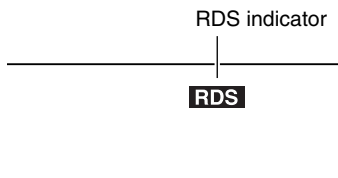

■ What is RDS?

RDS stands for *Radio Data System* and is a method of transmitting data in FM radio signals. It was developed by the European Broadcasting Union (EBU) and is available in most European countries. Many FM stations use it these days. In addition to displaying text information, RDS can also help you find radio stations by type (e.g., news, sport, rock, etc.).

The AV receiver supports four types of RDS information:

PS (Program Service)

When tuned to an RDS station that's broadcasting PS information, the station's name will be displayed. Pressing the [Display] button will display the frequency for 3 seconds.

RT (Radio Text)

When tuned to an RDS station that's broadcasting text information, the text will be shown on the display (see page 64).

PTY (Program Type)

This allows you to search RDS radio stations by type (see page 64).

TP (Traffic Program)

This allows you to search for RDS radio stations that broadcast traffic information (see page 64).

Notes:

- In some cases, the characters displayed on the AV receiver may not be identical to those broadcast by the radio station. Also, unexpected characters may be displayed when unsupported characters are received. This is not a malfunction.
- If the signal from an RDS station is weak, RDS data may be displayed intermittently or not at all.

RDS Program Types (PTY)

Type	Display
None	NONE
News reports	NEWS
Current affairs	AFFAIRS
Information	INFO
Sport	SPORT
Education	EDUCATE
Drama	DRAMA
Culture	CULTURE
Science and technology	SCIENCE
Varied	VARIED
Pop music	POP M
Rock music	ROCK M
Middle of the road music	EASY M
Light classics	LIGHT M
Serious classics	CLASSICS
Other music	OTHER M
Weather	WEATHER
Finance	FINANCE
Children's programmes	CHILDREN
Social affairs	SOCIAL
Religion	RELIGION
Phone in	PHONE IN
Travel	TRAVEL
Leisure	LEISURE
Jazz music	JAZZ
Country music	COUNTRY
National music	NATION M
Oldies music	OLDIES
Folk music	FOLK M
Documentary	DOCUMENT
Alarm test	TEST
Alarm	ALARM

Displaying Radio Text (RT)

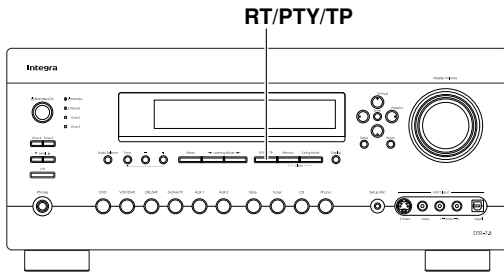

When tuned to an RDS station that's broadcasting text information, the text can be displayed.

	<p>Press the [RT/PTY/TP] button once.</p> <p>The RT information scrolls across the display.</p>
--	--

Notes:

- The message “Waiting” may appear while the AV receiver waits for the RT information.
- If the message “No Text Data” appears on the display, no RT information is available.

Finding Stations by Type (PTY)

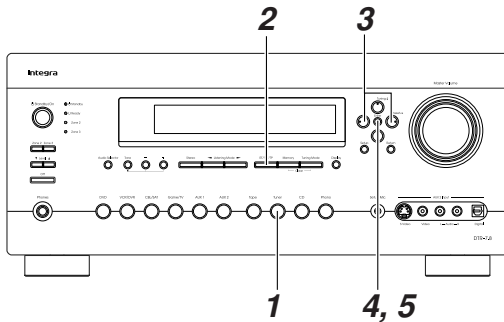

You can search for radio stations by type.

<p>1</p>	<p>Use the [Tuner] input selector button to select FM.</p>
<p>2</p>	<p>Press the [RT/PTY/TP] button twice.</p> <p>The current program type appears on the display.</p>
<p>3</p>	<p>Use the Preset [◀]/[▶] buttons to select the type of program you want.</p> <p>See the table on page 63.</p>

<p>4</p>	<p>To start the search, press [Enter].</p> <p>The AV receiver searches until it finds a station of the type you specified, at which point it stops briefly before continuing with the search.</p>
<p>5</p>	<p>When a station you want to listen to is found, press [Enter].</p> <p>If no stations are found, the message “Not Found” appears.</p>

Listening to Traffic News (TP)

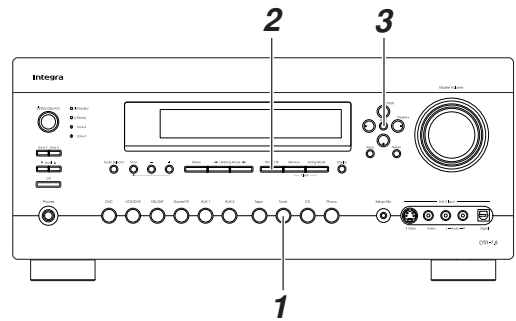

You can search for stations that broadcast traffic news.

<p>1</p>	<p>Use the [Tuner] input selector button to select FM.</p>
<p>2</p>	<p>Press the [RT/PTY/TP] button three times.</p> <p>If the current radio station is broadcasting TP (Traffic Program), “[TP]” will appear on the display and traffic news will be heard as and when it's broadcast. If “TP” without square brackets appears, this means that the station is not broadcasting TP.</p>
<p>3</p>	<p>To locate a station that is broadcasting TP, press [Enter].</p> <p>The AV receiver searches until it finds a station that's broadcasting TP. If no stations are found, the message “Not Found” appears.</p>

Listening to XM Satellite Radio® (North American Model Only)

Important XM Radio Information

XM Satellite Radio offers an extraordinary variety of commercial-free music, plus the best in sports, news, talk and entertainment. XM is broadcast in superior digital audio from coast to coast. From rock to reggae, from classical to hip hop, XM has something for every music fan. XM's dedication to playing the richest selection of music is matched by its passion for live sporting events, talk radio, up-to-the-minute news, stand-up comedy, children's programming, and much more. For U.S. customers, information about XM Satellite Radio is available online at www.xmradio.com. For Canadian customers, information about XM Canada is online at www.xmradio.ca.

Note:

Hardware and required monthly subscription sold separately. Other fees and taxes, including a one-time activation fee may apply. Subscription fee is consumer only. All fees and programming subject to change. Channels with frequent explicit language are indicated with an XL. Channel blocking is available for XM radio receivers by calling 1-800-XMRADIO (US residents) and 1-877-GET-XMSR (Canadian residents). For a full listing of the XM commercial-free channels and advertising-supported channels, visit lineup.xmradio.com (US residents) or xmradio.ca (Canadian residents).

Subscriptions subject to Customer Agreement available at xmradio.com (US residents) and xmradio.ca (Canadian residents). Only available in the 48 contiguous United States and Canada. ©2007 XM Satellite Radio Inc. All rights reserved. All other trademarks are the property of their respective owners.

A warning against reverse engineering:

It is prohibited to, and you agree that you will not, copy, decompile, disassemble, reverse engineer, hack, manipulate, or otherwise access and/or make available any technology incorporated in receivers compatible with the XM Satellite Radio system. Furthermore, the AMBE® voice compression software included in this product is protected by intellectual property rights including patent rights, copyrights, and trade secrets of Digital Voice Systems, Inc. The software is licensed solely for use within this product. The user of this or any other software contained in an XM Radio is explicitly prohibited from attempting to copy, decompile, reverse engineer, hack, manipulate or disassemble the object code, or in any other way convert the object code into human-readable form.

Connecting the XM Mini-Tuner and Home Dock

To receive XM Satellite Radio, you need an XM Mini-Tuner and Home Dock, which includes a home antenna. These are sold separately. For connection information, refer to the instruction manual supplied with the XM Mini-Tuner and Home Dock.

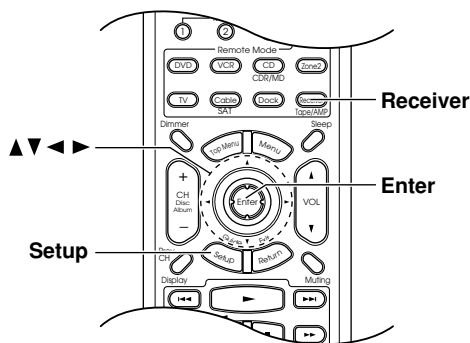
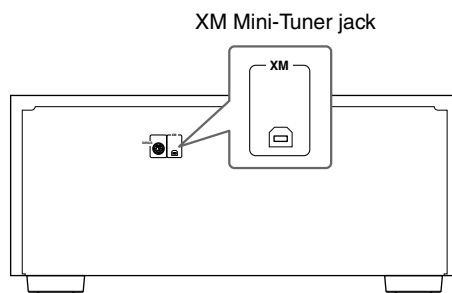

Setting the Satellite Radio Mode

Before you can listen to XM Satellite Radio, you must set the Satellite Radio mode to XM.

1



Press the [Receiver] Remote Mode button, followed by the [Setup] button.

The main menu appears onscreen.

2

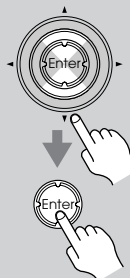

Use the Up and Down [▲]/[▼] buttons to select "7. Hardware Setup," and then press [Enter].

The Hardware Setup menu appears.

7. Hardware Setup	
1.	Remote Control
2.	Zone2/Zone3
3.	Tuner
4.	Analog Multich
5.	HDMI

3 Use the Up and Down [▲]/[▼] buttons to select “3. Tuner,” and then press [Enter].
The Tuner screen appears.

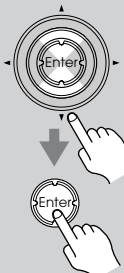
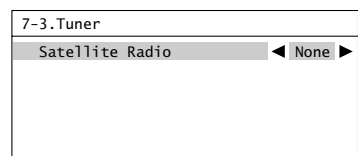

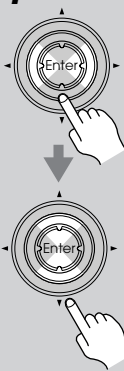

4 Use the Left and Right [◀]/[▶] buttons to select “XM.”
If there are 2 items on the Tuner screen, use Up and Down [▲]/[▼] buttons to select “Satellite Radio.”
Pressing the Left and Right [◀]/[▶] buttons cycles through the following options: None → XM → SIRIUS → XM/SIRIUS

- None:** Select if you’re not using satellite radio.
- XM:** Select to use XM Satellite Radio.
- SIRIUS:** Select to use SIRIUS Satellite Radio.
- XM/SIRIUS:** Select to use XM Satellite Radio and SIRIUS Satellite Radio.

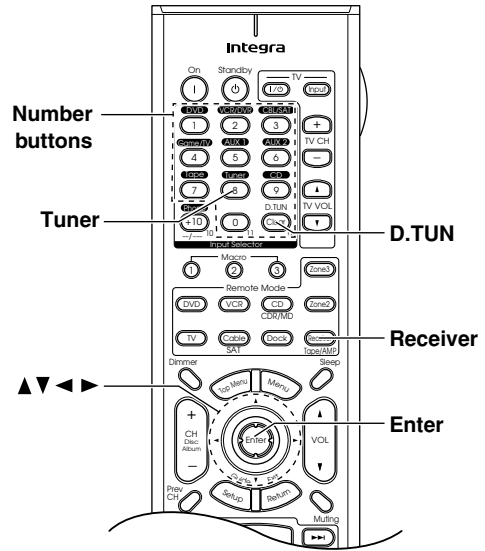

5 When you’ve finished, press the [Setup] button.
Setup closes.





Selecting XM Satellite Radio

AV receiver
Tuner



Remote controller
Receiver



Tuner



On the AV receiver, press the [Tuner] Input Selector button repeatedly to select XM.

On the remote controller, press the [Receiver] Remote Mode button, and then press the [Tuner] Input Selector button repeatedly to select XM.

If “CHECK XM TUNER” appears on the display, make sure the XM Mini-Tuner is connected properly.

Signing Up for XM Satellite Radio

Once you have installed the XM Mini-Tuner and Home Dock, you are ready to subscribe to XM Satellite Radio. You’ll need a major credit card and your XM Radio ID. There are three places you can find your 8-character XM Radio ID:

1. On the XM Mini-Tuner
2. On the XM Mini-Tuner packaging
3. On XM Channel 0, as explained below

1 Use the Tuning Up and Down [▲]/[▼] buttons to select RADIO ID.

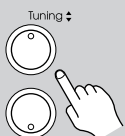

Your XM Radio ID number is displayed. Write it below for reference.

ID _____

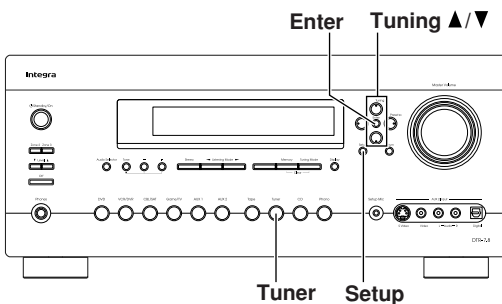

2

To sign up, go to:
<http://activate.xmradio.com>
 Or call: 1-800-967-2346
 For XM Canada, go to:
<http://xmradio.ca>
 Or call: 1-877-438-9677

Notes:

- RADIO ID cannot be selected in Category Search mode. You must select Channel Search mode (see right column).
- The following letters are not used in XM Satellite Radio IDs: I, O, S, F.
- XM Satellite Radio will transmit a special signal to your AV receiver to activate the full channel lineup. Activation normally takes between 10 and 15 minutes, but during busy peak periods, you may need to leave the AV receiver turned on for up to an hour.

Selecting XM Radio Channels

There are three ways to select XM radio channels:

1. **Channel Search mode:** select any channel.
2. **Category Search mode:** select channels by category.
3. **Direct tuning:** enter channel number.

Note:

You can't select Channel Search mode or Category Search mode while the Tuning Arrow indicators are flashing, as tuning is in progress.

■ Channel Search Mode

1

Press the [Receiver] Remote Mode button, and then press the [ENTER] button repeatedly to select Channel Search mode.



Channel Search

2

Use the Up and Down []/[] buttons to select a channel.

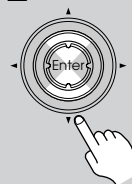

Channel number
 XM 050 5
 The Loft
 Channel name

You can also use the Left and Right []/[] buttons to select a category.

■ Category Search Mode

1

Press the [Receiver] Remote Mode button, and then press the [Enter] button repeatedly to select Category Search mode.



Category Search

2

Use the Left and Right []/[] buttons to select a category, and use the Up and Down []/[] buttons to select a channel in that category.



■ Direct Tuning

You can select an XM radio channel directly by entering its number.

1

Press the [Receiver] Remote Mode button, followed by the [D.TUN] button.

The [Receiver] button flashes.



XM

2

Within 8 seconds, use the number buttons to enter the channel number.

For example, to select channel #20, press 0, 2, 0, or 2, 0, [Enter].



Note:

While the [Receiver] button is flashing, you cannot select another input source with the remote controller.

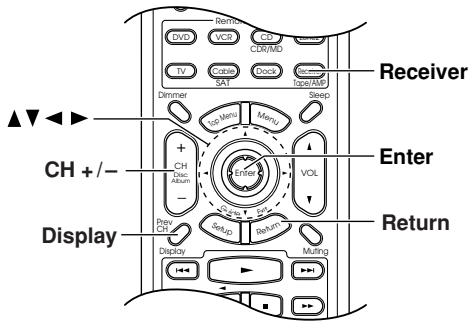
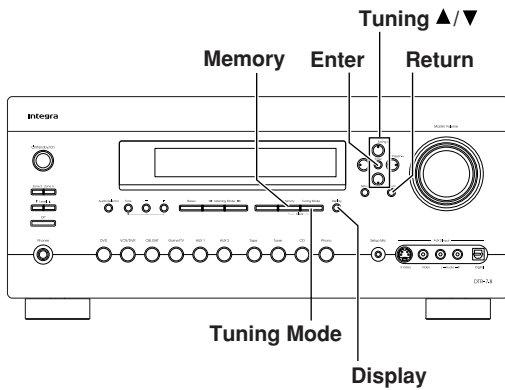

Selecting Channels on the AV receiver:

1 	Press the [Tuning Mode] button repeatedly to select Channel Search mode or Category Search mode.
2 	Press [Enter] repeatedly to select a category.
3 	Use the Tuning Up and Down [▲]/[▼] buttons to select a channel. In Channel Search mode, you can select any channel. In Category Search mode, you can only select channels from the currently selected category.

Selecting the Previous Channel:

AV receiver Remote controller 	To listen to the previously selected XM channel, press the [Return] button.
--	--

Displaying XM Radio Information

AV receiver Remote controller 	Press the [Display] button repeatedly to cycle through the available information.
--	--

The following information can be displayed:

- Channel name**
- ↓
- Channel number & preset number**
- ↓
- Category → Artist → Song title → Listening mode**

Notes:

- If the category, artist, or song title is not available, “- - -” will be displayed instead.
- The listening mode is not displayed when Zone 2 or Zone 3 is selected.

Positioning the XM Mini-Tuner System

You can check the signal strength of the XM radio signal and adjust the position of the XM Mini-Tuner system accordingly.

1 	Press the [Receiver] Remote Mode button, followed by the [Setup] button. The main menu appears onscreen.														
2 	Use the Up and Down [▲]/[▼] buttons to select “4. Source Setup,” and then press [Enter]. The Source Setup menu appears.														
	<table border="1" style="width: 100%;"> <tr> <td colspan="2" style="text-align: center;">4. Source Setup</td> </tr> <tr> <td style="width: 80%;"></td> <td style="text-align: right;">DVD</td> </tr> <tr> <td colspan="2">1. IntelliVolume</td> </tr> <tr> <td colspan="2">2. A/V Sync</td> </tr> <tr> <td colspan="2">3. Name Edit</td> </tr> <tr> <td colspan="2">4. Satellite Radio</td> </tr> <tr> <td colspan="2">5. SIRIUS Parental Lock</td> </tr> </table>	4. Source Setup			DVD	1. IntelliVolume		2. A/V Sync		3. Name Edit		4. Satellite Radio		5. SIRIUS Parental Lock	
4. Source Setup															
	DVD														
1. IntelliVolume															
2. A/V Sync															
3. Name Edit															
4. Satellite Radio															
5. SIRIUS Parental Lock															
	Note: • If the Satellite Radio mode is set to None (see page 66), the “4. Satellite Radio” item is not available.														

3

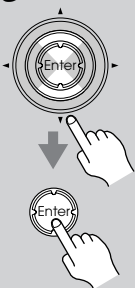

Use the Up and Down [▲]/[▼] buttons to select “4. Satellite Radio,” and then press [Enter].

The Satellite Radio screen appears. The name of the currently selected input selector is displayed in a box.

4

Position the XM Mini-Tuner Antenna so that as many bars as possible (up to 3) appear on the XM Satellite signal strength meter.

The best signal is achieved when the antenna is pointing to the southern sky through an unobstructed window.

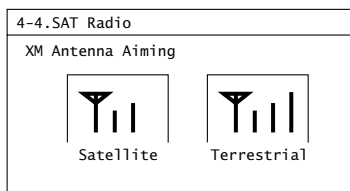

If you cannot receive a satellite signal, position the XM Mini-Tuner System so that as many bars as possible (up to 3) appear on the XM Terrestrial signal strength meter.

Notes:

- So long as the signal strength is good, you can enjoy XM Radio by using either satellite or terrestrial reception.
- Terrestrial signals are only available in certain areas.
- The XM information is only displayed when the Satellite Radio mode is set to XM or XM/SIRIUS (see page 66).
- If you're using both XM Satellite Radio and SIRIUS Satellite Radio and the Satellite mode is set to XM/SIRIUS (see page 66), signal strength meters for both systems appear on the same screen.

XM Radio Messages

The following messages may appear while using XM Satellite radio.

❑ CHECK ANTENNA

The XM antenna is not properly connected to the Mini-Tuner Dock. Check the connection. Check the antenna cable for damage.

❑ UPDATING

XM is updating your Mini-Tuner with the latest encryption code. Wait a few seconds until the update is done. Alternatively, you may be attempting to tune to a channel that is blocked or that you cannot receive with your subscription package. To receive that channel, contact XM Satellite Radio.

❑ NO SIGNAL

The XM Mini-Tuner cannot receive the satellite signal. Check the XM antenna for obstructions to the southern sky. Check the antenna positioning with the Antenna Aiming function (see left column).

❑ LOADING

The AV receiver is tuning or decoding audio or text data. Please wait. If this occurs often, check the XM antenna position with the Antenna Aiming function (see left column).

❑ OFF AIR

The XM channel you selected is not currently broadcasting. Select another channel.

❑ UPGRADE XM TUNER

The connected XM CNP-1000 is incompatible. The AV receiver features advanced technology that is designed for use with the XM Mini-Tuner. Contact XM Listener Care and ask about upgrading your XM CNP-1000 to an XM Mini-Tuner. Have the AV receiver's model name and CNP-1000 XM ID number ready beforehand, and explain that your AV receiver is displaying the message “Upgrade XM Tuner.” If you already have an XM Mini-Tuner connected and you see this message, turn off the AV receiver, make sure the XM Mini-Tuner is properly seated in the Mini-Tuner Dock, and then turn the AV receiver back on again. If the message reappears, contact XM Listener Care and explain the issue that you're experiencing and the corrective actions you've tried.

❑ CHECK XM TUNER

The AV receiver is having difficulty communicating with the XM Mini-Tuner module. Make sure the XM Mini-Tuner is properly seated in the Mini-Tuner Dock. And make sure the Mini-Tuner Dock cable is properly connected to the AV receiver and is not damaged. If the issue persists, contact XM Listener Care. Have the AV receiver's model name ready beforehand, and explain the issue that you're experiencing and the corrective actions you've tried.

❑ Unavailable Channel

You may be attempting to select a channel that is unavailable or has changed to a different channel number. Check xmradio.com for the latest channel listing.

Listening to SIRIUS Satellite Radio® (North American Models Only)

Important SIRIUS Satellite Radio Information

SIRIUS is available in the US for subscribers with addresses in the continental US and is available in Canada for subscribers with a Canadian address. To Get SIRIUS Satellite Radio a subscription and compatible tuner and antenna are required and sold separately. Visit sirius.com for the most complete and up-to-date channel lineup and information. “SIRIUS” and the SIRIUS dog logo and related marks are trademarks of SIRIUS Satellite Radio Inc.

Note:

Hardware and required basic monthly subscription sold separately. Installation costs and other fees and taxes, including a one-time activation fee may apply. Subscription fee is consumer only. All fees and programming subject to change.

What is SIRIUS Satellite Radio?

Simply The Best Radio on Radio™ with all your favorite entertainment including 100% commercial-free music, plus superior sports coverage, uncensored talk and comedy, world-class entertainment, news, weather and more for your car, home or office. For more information visit sirius.com or siriuscanada.ca

A warning against reverse engineering:

It is prohibited to copy, decompile, disassemble, reverse engineer, or manipulate any technology incorporated in receivers compatible with the SIRIUS Satellite Radio system.

“SIRIUS” and the SIRIUS dog logo are registered trademarks of SIRIUS Satellite Radio Inc.



Setting Up the SiriusConnect™ Home Tuner

The optional SiriusConnect Home tuner kit includes everything for easy home installation, including the SiriusConnect receiver, indoor/outdoor antenna with 21-foot cable, 8-pin mini DIN connector cable, and an AC power adapter. See the SiriusConnect Home tuner's instructions for more information.

Use the 8-pin mini DIN connector cable to connect the SiriusConnect receiver to the SIRIUS jack on the rear of the AV receiver.

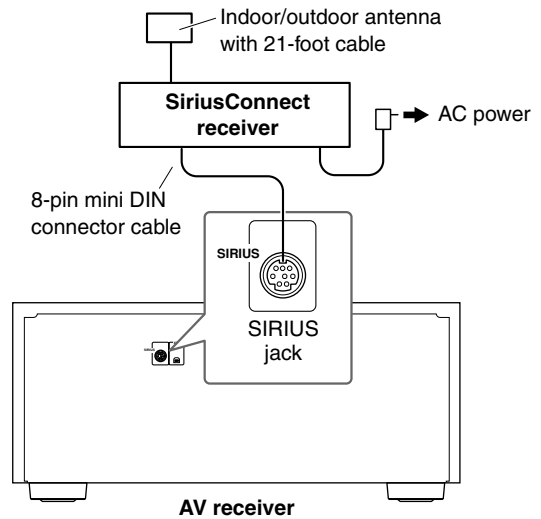

To use the included antenna indoors, you must place it at a north-, west-, or east-facing window, depending on where you live. If this isn't possible, you'll need to install it outside, away from any overhead obstructions.

Positioning the Antenna

For a consistent satellite signal, the antenna must be positioned correctly. Use the following map to determine which area you are in and position the antenna accordingly.

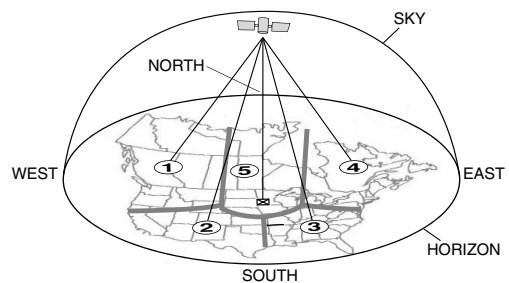

Area 1: Point the antenna toward the sky in the **east, northeast, or southeast**, either through a window or outside.

Area 2: Point the antenna toward the sky in the **north or northeast**, either through a window or outside.

Area 3: Point the antenna toward the sky in the **north or northwest**, either through a window or outside.

Area 4: Point the antenna toward the sky in the **west, northwest, or southwest**, either through a window or outside.

Area 5: Put the antenna outside and point it **straight up**. The antenna cannot be used indoors.

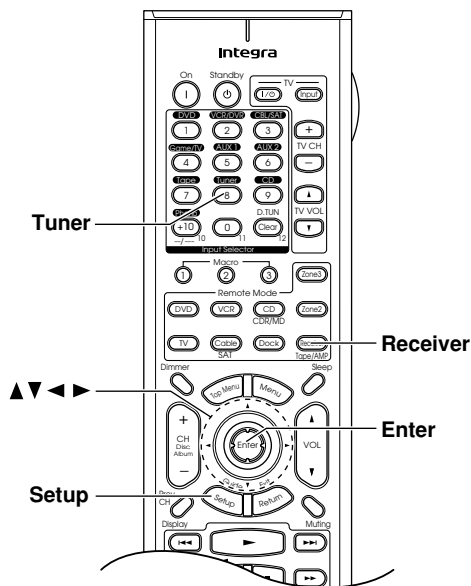
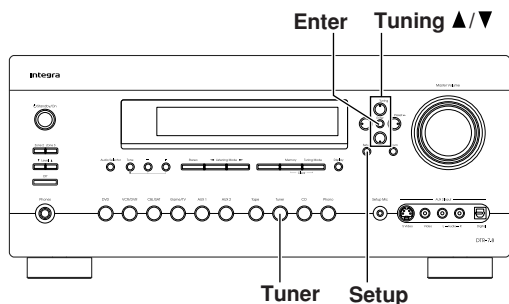

Setting the Satellite Radio Mode

Before you can listen to SIRIUS Satellite Radio, you must set the Satellite Radio mode to SIRIUS.

1

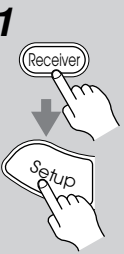

Press the [Receiver] Remote Mode button, followed by the [Setup] button.
The main menu appears onscreen.

2



Use the Up and Down [▲]/[▼] buttons to select “7. Hardware Setup,” and then press [Enter].
The Hardware Setup menu appears.

7. Hardware Setup	
1. Remote Control	
2. Zone2/Zone3	
3. Tuner	
4. Analog Multich	
5. HDMI	

3

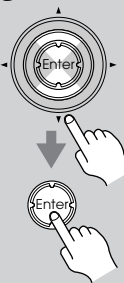

Use the Up and Down [▲]/[▼] buttons to select “3. Tuner,” and then press [Enter].
The Tuner screen appears.

7-3. Tuner	
Satellite Radio	◀ None ▶

4

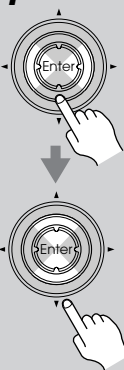

Use the Left and Right [◀]/[▶] buttons to select “SIRIUS.”
If there are 2 items on the Tuner screen, use Up and Down [▲]/[▼] buttons to select “Satellite Radio.”
Pressing the Left and Right [◀]/[▶] buttons cycles through the following options: None → XM → SIRIUS → XM/SIRIUS

- None:** Select if you're not using satellite radio.
- XM:** Select to use XM Satellite Radio.
- SIRIUS:** Select to use SIRIUS Satellite Radio.
- XM/SIRIUS:** Select to use XM Satellite Radio and SIRIUS Satellite Radio.

5



When you've finished, press the [Setup] button.
Setup closes.

Selecting SIRIUS Satellite Radio

AV receiver



On the AV receiver, press the [Tuner] Input Selector button repeatedly to select SIRIUS.

Remote controller

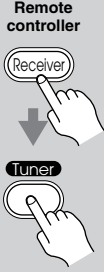

On the remote controller, press the [Receiver] Remote Mode button, and then press the [Tuner] Input Selector button repeatedly to select SIRIUS.

If “CHECK SR TUNER” appears on the display, make sure the SiriusConnect receiver is connected properly. If “ANTENNA ERROR” appears, make sure the antenna is connected properly.

Signing Up for SIRIUS Satellite Radio

Before you can use SIRIUS Satellite Radio, you must first sign up for an account. You'll need a major credit card and your *SIRIUS Satellite Radio ID*, which you can get from the AV receiver, as explained below, or from the SiriusConnect Home tuner package.

1	<p>Use the TUNING Up and Down [▲]/[▼] buttons to select channel 0.</p> <p>Your SIRIUS Satellite Radio ID number is displayed. Write it below.</p> <p style="text-align: center;">ID _____</p>
2	<p>To sign up, go to: http://activate.siriusradio.com Or call: 1-888-539-SIRIUS (7474)</p>

Note:

- Your ID is also displayed on the Satellite Radio screen. See "Positioning the SiriusConnect Home Antenna" on page 76.

Selecting SIRIUS Satellite Radio Channels

There are three ways to select SIRIUS Satellite Radio channels:

- Channel Search mode:** select any channel.
- Category Search mode:** select channels by category.
- Direct tuning:** enter channel number.

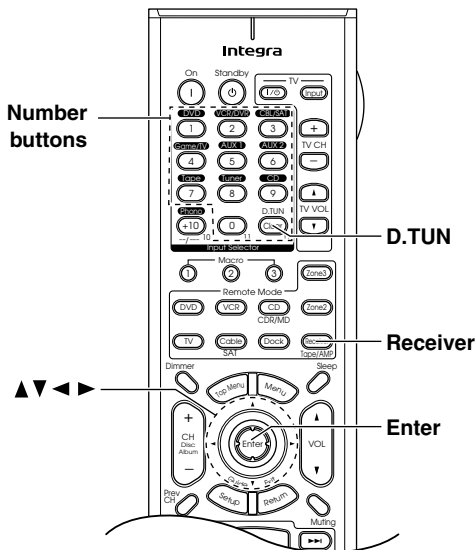

Channel Search Mode

1	<p>Press the [Receiver] Remote Mode button, and then press the [Enter] button repeatedly to select Channel Search mode.</p> <p style="text-align: center;">Channel Search</p>
2	<p>Use the Up and Down [▲]/[▼] buttons to select a channel.</p> <p style="text-align: center;">Channel number SR 050 Hot Jams Channel name</p> <p>You can also use the Left and Right [◀]/[▶] buttons to select a category.</p>

Category Search Mode

1	<p>Press the [Receiver] Remote Mode button, and then press the [Enter] button repeatedly to select Category Search mode.</p> <p style="text-align: center;">Category Search</p>
2	<p>Use the Left and Right [◀]/[▶] buttons to select a category, and use the Up and Down [▲]/[▼] buttons to select a channel in that category.</p>

Direct Tuning

You can select a SIRIUS Satellite Radio channel directly by entering its number.

1	<p>Press the [Receiver] Remote Mode button, followed by the [D.TUN] button.</p> <p>The [Receiver] button flashes.</p> <p style="text-align: center;">SR</p>
----------	--

2



Within 8 seconds, use the number buttons to enter the channel number.

For example, to select channel #20, press 0, 2, 0, or 2, 0, [Enter].

Note:

While the [Receiver] button is flashing, you cannot select another input source with the remote controller.

Notes:

- If you select an unavailable channel, “INVALID CHANNEL” appears on the display.
- If you select a channel that you are not subscribed to, “CALL SIRIUS” appears on the display.
- Channels that are locked must be unlocked before you can listen to them. See “Parental Lock” on right column for more information.

Selecting Channels on the AV receiver:

1

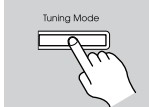

Press the [Tuning Mode] button repeatedly to select Channel Search mode or Category Search mode.

2



Press [Enter] repeatedly to select a category.

3

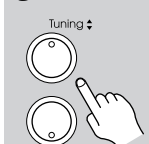

Use the Tuning Up and Down [▲]/[▼] buttons to select a channel.

In Channel Search mode, you can select any channel.

In Category Search mode, you can only select channels from the currently selected category.

Selecting the Previous Channel:

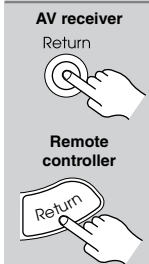

To listen to the previously selected SIRIUS Satellite Radio channel, press the [Return] button.

Parental Lock

With SIRIUS Parental Lock, you can lock out channels that you do not want to receive and use a 4-digit PIN number to prevent others from unlocking them.

1

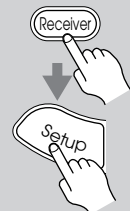

Press the [Receiver] Remote Mode button, followed by the [Setup] button.

The main menu appears onscreen.

2

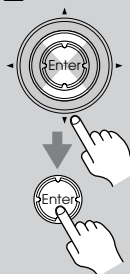

Use the Up and Down [▲]/[▼] buttons to select “4. Source Setup,” and then press [Enter].

The Source Setup menu appears.

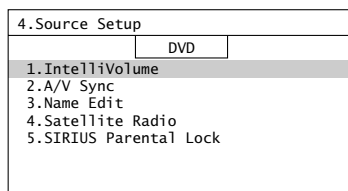

Note:

If the Satellite Radio mode is set to None or XM (see page 71), the “5. SIRIUS Parental Lock” item is not available.

3

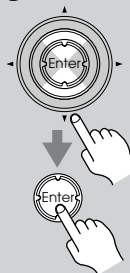

Use the Up and Down [▲]/[▼] buttons to select “5. SIRIUS Parental Lock,” and then press [Enter].

The SIRIUS Parental Lock screen appears.

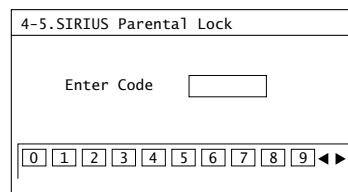

4 Press the [D.TUN] button, and then use the number buttons to enter the 4-digit PIN number.

Or

Use the Left and Right [◀]/[▶] buttons to select a number on the screen, and then press [Enter]. Repeat this for each of the four digits in the PIN number.

If you're entering the PIN number for the very first time, the PIN is stored, and the following screen appears.

4-5.SIRIUS Parental Lock	
Edit Code Parental Lock	

If you've already set a PIN number, you must enter the correct PIN to get to this screen. If you enter the wrong PIN, the message "Wrong Code!" appears and you'll have to enter the PIN again.

5 Use the Up and Down [▲]/[▼] buttons to select "Parental Lock," and then press [Enter].

The Parental Lock screen appears.

4-5.SIRIUS Parental Lock	
Parental Lock	
Channel	Status
0ch	wwwwwwww
Locked	

▲▼: CHANNEL [ENT]:SAVE
 ▲▶: STATUS [RET]:RETURN

6 Use the Up and Down [▲]/[▼] buttons to select a channel, and use the Left and Right [◀]/[▶] buttons to select Locked or Unlocked.

The number, name, and status of the currently selected channel is displayed.

7 When you've finished, press [Enter] to save your changes, or press [Return] to return to the previous screen without saving.

When [Enter] is pressed, the confirmation message "Locked" or "Unlocked" appears.

8 Press the [Setup] button.

Setup closes.

- Notes:**
- While a channel is locked, it cannot be selected for listening.
 - To unlock a channel, you must enter the correct PIN number and change it to Unlocked in step 6.

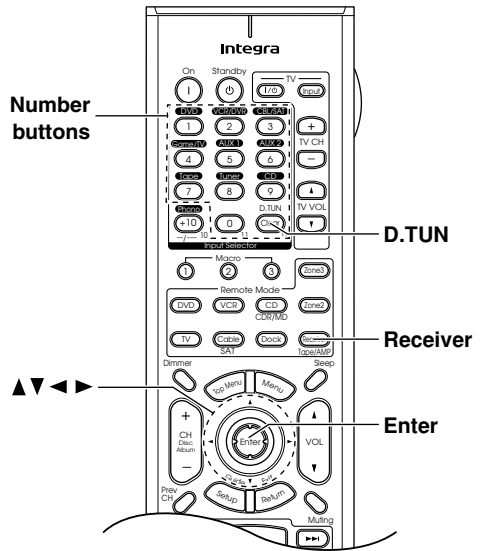

Changing the PIN Number

1 Press the [Receiver] Remote Mode button, followed by the [Setup] button.

The main menu appears onscreen.

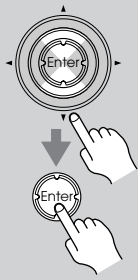
2

Use the Up and Down [▲]/[▼] buttons to select “4. Source Setup,” and then press [Enter]. The Source Setup menu appears.

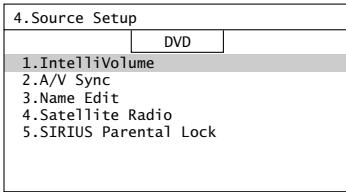

Note:
If the Satellite Radio mode is set to None or XM (see page 71), the “5. SIRIUS Parental Lock” item is not available.

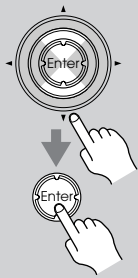
3

Use the Up and Down [▲]/[▼] buttons to select “5. SIRIUS Parental Lock,” and then press [Enter]. The SIRIUS Parental Lock screen appears.

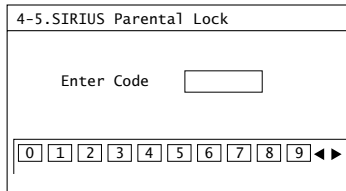
**4**

Press the [D.TUN] button, and then use the number buttons to enter the old 4-digit PIN number.

Or



Use the Left and Right [◀]/[▶] buttons to select a number on the screen, and then press [Enter]. Repeat this for each of the four digits in the old PIN number.

If you enter the correct PIN number, the following screen appears.

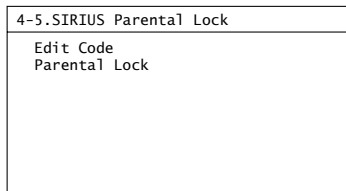

If you enter the wrong PIN number, the message “Wrong Code!” appears and you’ll have to enter the PIN again.

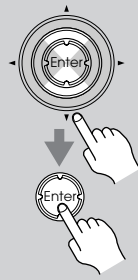
5

Use the Up and Down [▲]/[▼] buttons to select “Edit Code,” and then press [Enter]. The New Code screen appears.

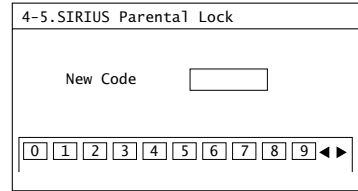
**6**

Press the [D.TUN] button, and then use the number buttons to enter the new 4-digit PIN number.

Or



Use the Left and Right [◀]/[▶] buttons to select a number on the screen, and then press [Enter]. Repeat this for each of the four digits in the new PIN number.

The Confirm screen appears.

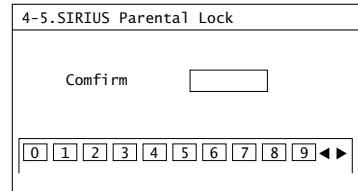
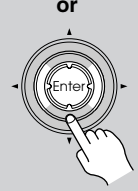
**7**

Confirm the new PIN number by entering it again.

If you confirm the PIN number correctly, the new PIN is saved and the message “Complete” appears.

If you confirm the PIN number incorrectly, “Wrong Code!” appears, and you’ll be returned to step 5 to try again.

8

Press the [Setup] button. Setup closes.

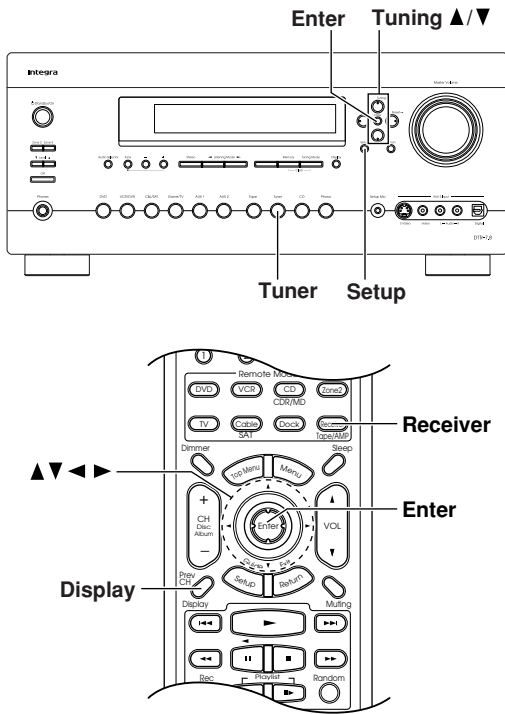

Displaying SIRIUS Satellite Radio Information

AV receiver
 Display

Remote controller
 Display

Press the [Display] button repeatedly to cycle through the available information.

The following information can be displayed:

- Channel name
- ↓
- Channel number & preset number
- ↓
- Category
- ↓
- Artist/composer
- ↓
- Song title
- ↓
- Listening mode

Notes:

- If the category, artist/composer, or song title is not available, “- - -” will be displayed instead.

Positioning the SiriusConnect Home Antenna

You can check the strength of the SIRIUS Satellite Radio signal and adjust the position of the SiriusConnect Home antenna accordingly.

1

Press the [Receiver] Remote Mode button, followed by the [Tuner] button, and [Setup] button.
 The main menu appears onscreen.

2

Use the Up and Down [▲]/[▼] buttons to select “4. Source Setup,” and then press [Enter].
 The Source Setup menu appears.

4. Source Setup	
	DVD
1. IntelliVolume	
2. A/V Sync	
3. Name Edit	
4. Satellite Radio	
5. SIRIUS Parental Lock	

Note:
 If the Satellite Radio mode is set to None (see page 71), the “4. Satellite Radio” item is not available.

3

Use the Up and Down [▲]/[▼] buttons to select “4. Satellite Radio,” and then press [Enter].
 The Satellite Radio screen appears.
 The name of the currently selected input selector is displayed in a box.

4

Position the SiriusConnect Home antenna so that as many bars as possible (up to 3) appear on the SIRIUS Satellite signal strength meter.

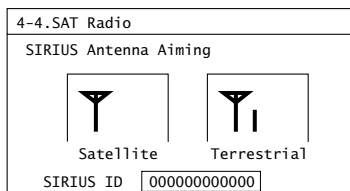

If you cannot receive a satellite signal, position the SiriusConnect Home antenna so that as many bars as possible (up to 3) appear on the SIRIUS Terrestrial signal strength meter.

Notes:

- So long as the signal strength is good, you can enjoy SIRIUS Satellite Radio by using either satellite or terrestrial reception.
- Terrestrial signals are only available in certain areas.
- The SIRIUS information on the Satellite Radio screen is only displayed when the Satellite Radio mode is set to SIRIUS or XM/SIRIUS (see page 71).
- If you're using both XM Satellite Radio and SIRIUS Satellite Radio and the Satellite mode is set to XM/SIRIUS (see page 71), signal strength meters for both systems appear on the same screen.

SIRIUS Satellite Radio Messages

The following messages may appear while using SIRIUS Satellite Radio.

ACQUIRING

The SiriusConnect receiver is acquiring the signal or no signal is present. Make sure the SiriusConnect Home tuner is connected properly and that there are no obstacles close by.

ANTENNA ERROR

Make sure the SiriusConnect Home tuner is connected properly.

SUB UPDATED

Displayed while your subscription is being updated. No operations can be performed until this message has cleared.

UPDATING XXX%

Displayed while the channel map is being updated. Wait until the updating is complete.

UPDATING

Displayed while the SiriusConnect receiver's firmware is being updated.

INVALID CHANNEL

Displayed if you select an unavailable channel.

CALL SIRIUS

Displayed when you select a channel to which you are not subscribed. Call SIRIUS if you want to subscribe.

CHECK SR TUNER

Displayed if the SiriusConnect receiver is not connected. Make sure the SiriusConnect receiver is connected properly, and make sure its AC adapter is plugged in.

Presetting AM, FM, XM, and SIRIUS Stations

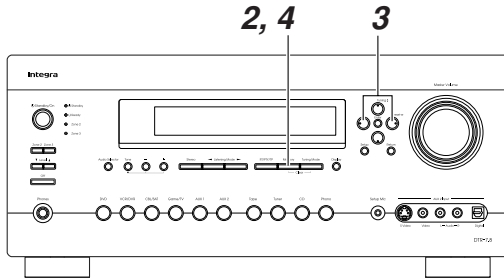

You can store a combination of up to 40 of your favorite AM, FM, XM, and SIRIUS radio stations.

- | | |
|----------|--|
| 1 | <p>Tune into the AM, FM, XM, or SIRIUS station you want to store as a preset.</p> |
| 2 | <p>Press the [Memory] button.
The preset number flashes.</p> |
| 3 | <p>While the preset number is flashing (about 8 seconds), use the Preset [◀]/[▶] buttons to select a preset from 1 through 40.</p> |
| 4 | <p>Press the [Memory] button again to store the station.
The station is stored and the preset number stops flashing.
Repeat this procedure for all of your favorite stations.</p> |

Note:

- You can name your radio presets for easy identification (see page 104).

Selecting Presets

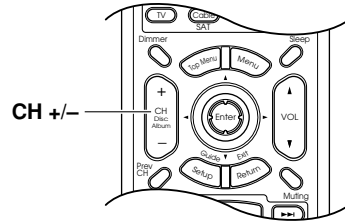
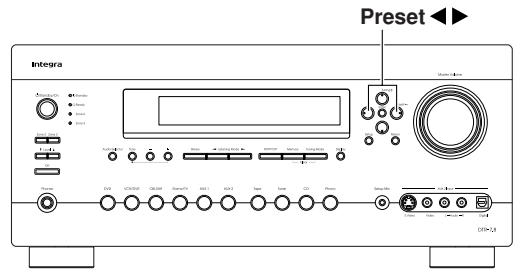

- | | |
|----------|--|
| 1 | <p>To select a preset, use the Preset [◀]/[▶] buttons or the remote controller's CH +/- button.</p> |
|----------|--|

Deleting Presets

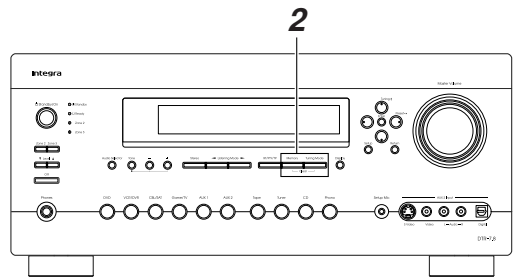

- | | |
|----------|---|
| 1 | <p>Select the preset that you want to delete.
See the previous section.</p> |
| 2 | <p>While holding down the [Memory] button, press the [Tuning Mode] button.
The preset is deleted and its number disappears from the display.</p> |

Common Functions

This section explains functions that can be used with any input source.

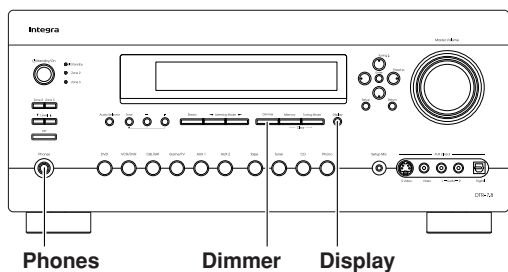
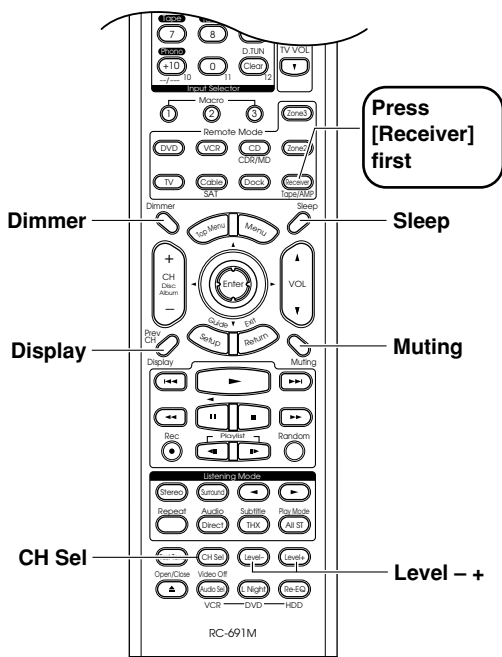

Setting the Display Brightness

You can adjust the brightness of the display.

Remote controller

Dimmer



Press the remote controller's [Dimmer] button repeatedly to select: Normal, Dim, or Dimmer.

You can also use the AV receiver's [Dimmer] button (not Australian models).

AV receiver

Dimmer



Adjusting Speaker Levels

You can adjust the volume of each speaker while listening to an input source. These temporary adjustments are cancelled when the AV receiver is set to Standby.

Use the remote controller's [CH Sel] button to select each speaker, and use the [Level-] and [Level+] buttons to adjust the volume.

You can adjust the volume of each speaker from -12 dB to +12 dB (-15 dB to +12 dB for the subwoofer).

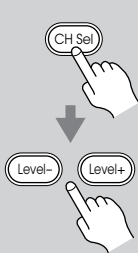

Left : 0.0dB

Notes:

- You cannot use this function while the AV receiver is muted.
- Speakers that are set to No or None in the Speaker Configuration cannot be adjusted (see page 96).

Headphones

While a pair of headphones is connected, you can use the [CH Sel], [Level-], and [Level+] buttons to adjust the volume of each headphone speaker (left and right), from -12 dB to +12 dB each.

HP Left : -3.5dB

These settings are stored when the AV receiver is set to Standby.

Muting the AV Receiver

You can temporarily mute the output of the AV receiver.

Press the remote controller's [Muting] button.

The output is muted and the MUTING indicator flashes on the display.





MUTING

To unmute the AV receiver, press the remote controller's [Muting] button again, or adjust the volume. The output is unmuted and the MUTING indicator goes off. Muting is cancelled when the AV receiver is set to Standby.

Tip:

You can specify how much the output is muted with the Muting Level setting (see page 106).

Using the Sleep Timer

With the sleep timer, you can set the AV receiver so that it turns off automatically after a specified period.



Press the remote controller's [Sleep] button repeatedly to select the required sleep time.

You can set the sleep time from 90 to 10 minutes in 10 minute steps.

The SLEEP indicator appears on the display when the sleep timer has been set, as shown. The specified sleep time appears on the display for about 5 seconds, then the previous display reappears.

SLEEP indicator

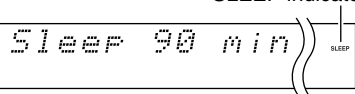

To cancel the sleep timer, press the [Sleep] button repeatedly until the SLEEP indicator disappears.

To check the remaining sleep time, press the [Sleep] button. Note that if you press the [Sleep] button while the sleep time is being displayed, you'll shorten the sleep time by 10 minutes.

Using Headphones

For private listening, you can connect a pair of stereo headphones (1/4-inch phone plug) to the AV receiver's Phones jack.

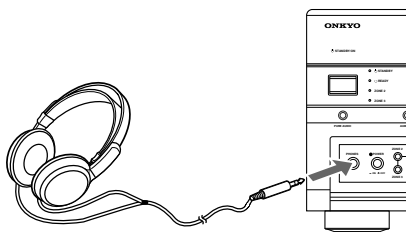

Notes:

- Always turn down the volume before connecting your headphones.
- While the headphones plug is inserted in the Phones jack, the speakers are turned off and the Headphone indicator lights up. (The Powered Zone 2 speakers are not turned off.)
- When you connect a pair of headphones, the listening mode is set to Stereo, unless it was already set to Mono, Stereo, or Direct, in which case it stays the same.

Displaying Source Information

You can display various information about the current input source as follows.

Remote controller

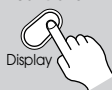

AV receiver



Press the [Display] button repeatedly to cycle through the available information.

The following information can typically be displayed:

Input source	DVD
Listening mode	Pure Audio
	↓ ↑
Signal format*	DTS-HDMSTR 5.1
Sampling frequency	fs: 96 kHz

*If the input signal is analog, no format information is displayed. If the input signal is PCM, the sampling frequency is displayed. If the input signal is digital but not PCM, the signal format and the number of channels is displayed. For some digital input signals, including multichannel PCM, the signal format, number of channels, and sampling frequency is displayed.

Information is displayed for about 3 seconds, then the previous display reappears.

Selecting Audio Inputs

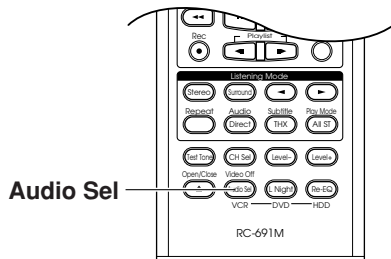

If you connect a component to more than one audio input, such as a DVD player connected to analog, digital, multichannel, and HDMI inputs, you can use the [Audio Sel] button to select which audio input you want to use to listen to that component.



Press the [Audio Sel] button repeatedly to select an audio input: HDMI > Auto > Multich > Analog.

HDMI: Selects the assigned HDMI IN, and the HDMI indicator appears on the display. (The HDMI IN must already be assigned to the current input selector. See page 46.)

Auto: Selects the assigned COAXIAL or OPTICAL DIGITAL IN, and the DIGITAL indicator appears on the display. (The DIGITAL IN must already be assigned to the current input selector. See page 50.) If there is no digital signal, the analog input is used instead.

Multich: Selects the multichannel input, and the ANALOG indicator appears on the display. (The multichannel input must already be assigned to the current input selector. See page 52.)

Analog: Selects the analog input, and the ANALOG indicator appears on the display.

You can also use the [Audio Selector] button on the AV receiver.

Specifying the Digital Signal Format

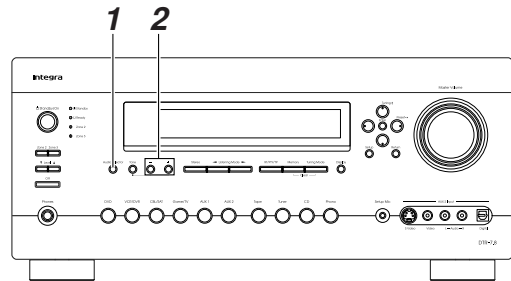

Normally, the AV receiver detects the format of digital input signals automatically. However, if you experience either of the following issues when playing PCM or DTS sources, you can specify the signal format manually.

- If the beginnings of tracks from a PCM source are cut off, try the PCM setting.
- If noise is produced when fast forwarding or rewinding a DTS CD, try the DTS setting.

1

Audio Selector



Press the [Audio Selector] button repeatedly to select Auto.

2

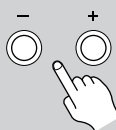

While “Auto” is shown on the display, use the Tone Plus [+] and Minus [-] buttons to select:

PCM: Only input signals in PCM format are output, and the PCM indicator lights up. The indicator flashes if the input signal is not PCM.

DTS: Only input signals in DTS format are output, and the DTS indicator lights up. The indicator flashes if the input signal is not DTS.

Auto (default): The format is detected automatically. If no digital input signal is present, the analog input is used instead.

Using the Listening Modes

Selecting the Listening Modes

For a description of each listening mode, see “About the Listening Modes” on page 87.

- The Dolby Digital and DTS listening modes can only be selected if your DVD player is connected to the AV receiver with a digital audio connection (coaxial, optical, or HDMI).
- The listening modes you can select depends on the format of the input signal. To check the format, see “Displaying Source Information” on page 80.
- While a pair of headphones is connected, you can only select the Mono, Direct, or Stereo listening mode.

Selecting on the AV Receiver

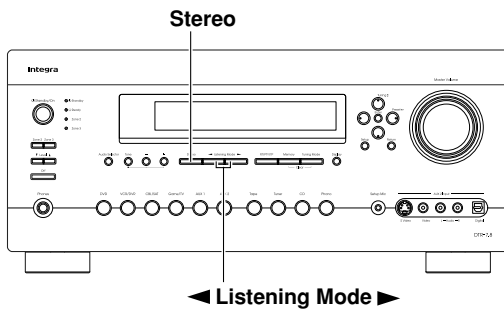

- **[Stereo] button**
This button selects the Stereo listening mode.
- **Listening Mode [◀/▶] buttons**
Pressing these buttons repeatedly cycles through all of the listening modes that can be used with the current input source.

Selecting with the Remote Controller

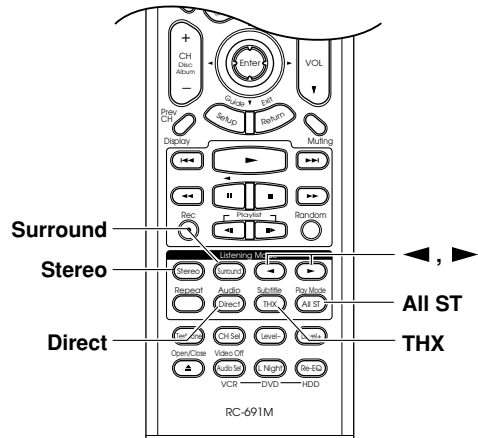

- **[Stereo] button**
This button selects the Stereo listening mode.
- **[Surround] button**
This button selects the Dolby Digital and DTS listening modes.
- **Listening Mode [◀/▶] buttons**
Pressing these buttons repeatedly cycles through all of the listening modes that can be used with the current input source.
- **[Direct] button**
This button selects the Direct listening mode.
- **[THX] button**
This button selects the THX listening modes.
- **[All ST] button**
This button selects the All Channel Stereo listening mode.

Using the Listening Modes—Continued

Listening Modes Available for Each Source Format

Analog and PCM Sources

Button	Source format Media Listening Mode	PCM		Multi channel analog	Multichannel PCM					
		32–96 kHz	176.4/192kHz* ¹		32–96 kHz			176.4/192 kHz* ¹		
					except * ² /2	* ² /2	2ch	1/0, 1+1	Multichannel	2ch
		CD, TV, radio,		DVD	DVD			DVD		
[Direct]	Direct	✓	✓	✓	✓	✓	✓	✓	✓	✓
[Stereo]	Stereo	✓	✓		✓	✓	✓	✓	✓	✓
[Surround]	Multichannel			✓	✓	✓			✓	
	Dolby D									
	Dolby D Plus									
	DTS, DTS 96/24									
	DTS-ES Discrete/Matrix									
	DTS-HD High Resolution									
	DTS-HD Master Audio									
	Dolby TrueHD									
	DSD									
	Dolby PLII Movie/ Dolby PLIIx Movie* ²	✓					✓	✓		
	Dolby PLII Music/ Dolby PLIIx Music* ²	✓					✓	✓		
	Dolby PLII Game/ Dolby PLIIx Game* ²	✓						✓		
	Dolby Digital EX/Dolby EX						✓			
	Neo:6						✓			
	Neo:6 Cinema	✓						✓		
Neo:6 Music	✓						✓			
Neural THX 5.1	✓						✓			
Neural THX 7.1	✓					✓	✓			
[THX]	THX Cinema* ³				✓	✓				
	Dolby PLII/ Dolby PLIIx THX* ³	✓* ²				✓	✓			
	Neo:6 THX* ³	✓* ³				✓	✓			
	Dolby PLII THX Games Mode	✓					✓			
	Neo:6 THX Games Mode	✓					✓			
	THX Surround EX						✓			
	THX Ultra2 Cinema						✓			
	THX Music Mode						✓			
	THX Games Mode						✓			
Listening Mode* ⁴ [4]/[P]	Mono	✓			✓	✓	✓	✓		
	Onkyo Original DSP									
	Mono Movie Orchestra Unplugged Studio-Mix TV Logic All Ch Stereo Full Mono T-D	✓				✓	✓	✓	✓	

*1. DVD-Audio discs output multichannel 176.4/192 kHz PCM only via HDMI.

*2. If there are no surround back speakers, or Powered Zone 2 is being used, Dolby Pro Logic II is used.

*3. Available only when using surround speakers.

*4. For T-D, Mono Movie, Orchestra, Unplugged, Studio-Mix, and TV Logic, PCM of 64 kHz, 88.2 kHz, and 96 kHz are processed at 32 kHz, 44.1 kHz, and 88.2 kHz respectively.

Requires 6.1/7.1 speakers. Not available while Powered Zone 2 is being used.

Requires 7.1 speakers. Not available while Powered Zone 2 is being used.

Using the Listening Modes—Continued

DSD, Dolby Digital, and Dolby Digital Plus Sources

Button	Source format	DSD*1		Dolby D				Dolby Digital Plus			
		Multichannel		Multichannel		2ch	1/0, 1+1	Multichannel		2ch	1/0, 1+1
		3/2	2ch	except *2	*2			except *2	*2		
Listening Mode	Media	SACD		DVD, DTV, etc.				Blu-ray, HD DVD			
[Direct]	Direct	✓*2	✓*2	✓	✓	✓	✓	✓	✓	✓	✓
[Stereo]	Stereo	✓	✓	✓	✓	✓	✓	✓	✓	✓	✓
[Surround]	Multichannel										
	Dolby D			✓	✓						
	Dolby D Plus							✓*3	✓*3		
	DTS, DTS 96/24										
	DTS-ES Discrete/Matrix										
	DTS-HD High Resolution										
	DTS-HD Master Audio										
	Dolby TrueHD										
	DSD	✓									
	Dolby PLII Movie/ Dolby PLIIx Movie*4	✓	✓		✓	✓			✓	✓	
	Dolby PLII Music/ Dolby PLIIx Music*4	✓	✓		✓	✓			✓	✓	
	Dolby PLII Game/ Dolby PLIIx Game*4		✓			✓				✓	
	Dolby Digital EX/Dolby EX	✓			✓				✓		
	Neo:6	✓			✓				✓		
	Neo:6 Cinema		✓			✓				✓	
	Neo:6 Music		✓			✓				✓	
Neural THX 5.1		✓			✓				✓		
Neural THX 7.1	✓	✓		✓	✓			✓	✓		
[THX]	THX Cinema*5	✓		✓	✓			✓	✓		
	Dolby PLII/ Dolby PLIIx THX	✓	✓		✓	✓			✓	✓	
	Neo:6 THX	✓	✓		✓	✓			✓	✓	
	Dolby PLII THX Games Mode		✓		✓	✓			✓	✓	
	Neo:6 THX Games Mode		✓		✓	✓			✓	✓	
	THX Surround EX	✓			✓				✓		
	THX Ultra2 Cinema	✓			✓				✓		
	THX Music Mode	✓			✓				✓		
THX Games Mode	✓			✓				✓			
Listening Mode [◀/▶]	Mono	✓	✓	✓	✓	✓	✓	✓	✓	✓	✓
	Onkyo Original DSP Mono Movie Orchestra Unplugged Studio-Mix TV Logic All Ch Stereo Full Mono T-D	✓	✓	✓	✓	✓	✓	✓	✓	✓	✓

*1. In listening modes other than DSD Direct, DSD sources are converted and handled as PCM.

*2. With the Delay Enable DSD setting on the Direct screen set to No (see page 93), if the source is DSD, the Direct listening mode becomes DSD Direct, “DSD Direct” appears on the display, and the Speaker Configuration settings are ignored.

*3. If there are no surround back speakers, depending on the input signal, Dolby Digital may be used.

*4. If there are no surround back speakers, or Powered Zone 2 is being used, Dolby Pro Logic II is used.

*5. Available only when using surround speakers.

Requires 6.1/7.1 speakers. Not available while Powered Zone 2 is being used.

Requires 7.1 speakers. Not available while Powered Zone 2 is being used.

Using the Listening Modes—Continued

TrueHD and DTS Sources

Button	Source format	TrueHD ^{*1}				DTS, DTS96/24				DTS-ES Discrete/Matrix
		Multichannel		2ch	1/0, 1+1	Multichannel		2ch	1/0	
		except *1/2	*1/2			except *1/2	*1/2			
Listening Mode	Media	Blu-ray, HD DVD				DVD, CD, etc.				
[Direct]	Direct	✓	✓	✓	✓	✓	✓	✓	✓	✓
[Stereo]	Stereo	✓	✓	✓	✓	✓	✓	✓	✓	✓
[Surround]	Multichannel									
	Dolby D									
	Dolby D Plus									
	DTS, DTS 96/24					✓	✓			
	DTS-ES Discrete/Matrix									✓ ^{*2}
	DTS-HD High Resolution									
	DTS-HD Master Audio									
	TrueHD	✓	✓							
	DSD									
	Dolby PLII Movie/ Dolby PLIIx Movie ^{*3}			✓	✓		✓	✓		
	Dolby PLII Music/ Dolby PLIIx Music ^{*3}			✓	✓		✓	✓		
	Dolby PLII Game/ Dolby PLIIx Game ^{*3}				✓			✓		
	Dolby Digital EX/Dolby EX			✓			✓			
	Neo:6			✓			✓			
	Neo:6 Cinema				✓			✓		
	Neo:6 Music				✓			✓		
Neural THX 5.1				✓			✓			
Neural THX 7.1			✓	✓		✓	✓		✓	
[THX]	THX Cinema ^{*4}	✓	✓			✓	✓			✓
	Dolby PLII/ Dolby PLIIx THX			✓	✓		✓	✓		
	Neo:6 THX			✓	✓		✓	✓		
	Dolby PLII THX Games Mode				✓			✓		
	Neo:6 THX Games Mode				✓			✓		
	THX Surround EX			✓			✓			
	THX Ultra2 Cinema			✓			✓			✓
	THX Music Mode			✓			✓			✓
	THX Games Mode			✓			✓			✓
Listening Mode ^{*5} [◀]/[▶]	Mono					✓	✓	✓	✓	✓
	Onkyo Original DSP Mono Movie Orchestra Unplugged Studio-Mix TV Logic All Ch Stereo Full Mono T-D	✓	✓	✓	✓	✓	✓	✓	✓	✓

*1. 192 kHz TrueHD sources are processed as 192 kHz/2-channel audio signal, regardless its number of channels.

*2. If there are no surround back speakers, or Powered Zone 2 is being used, DTS is used.

*3. If there are no surround back speakers, or Powered Zone 2 is being used, Dolby Pro Logic II is used.

*4. Available only when using surround speakers.

*5. For T-D, Mono Movie, Orchestra, Unplugged, Studio-Mix, and TV Logic, DTS 96/24 is processed as DTS.

Requires 6.1/7.1 speakers. Not available while Powered Zone 2 is being used.

Requires 7.1 speakers. Not available while Powered Zone 2 is being used.

Using the Listening Modes—Continued

DTS-HD Sources

Button	Source format	DTS-HD High Resolution				DTS-HD Master Audio ^{*1}			
		Multichannel		2ch	1/0	Multichannel		2ch	1/0
		except */2	*/2			except */2	*/2		
Listening Mode	Media	Blu-ray, HD DVD				Blu-ray, HD DVD			
[Direct]	Direct	✓	✓	✓	✓	✓	✓	✓	✓
[Stereo]	Stereo	✓	✓	✓	✓	✓	✓	✓	✓
[Surround]	Multichannel								
	Dolby D								
	Dolby D Plus								
	DTS, DTS 96/24								
	DTS-ES Discrete/Matrix								
	DTS-HD High Resolution	✓	✓						
	DTS-HD Master Audio					✓	✓		
	TrueHD								
	DSD								
	Dolby PLII Movie/ Dolby PLIIx Movie ^{*2}			✓ ^{*3}	✓ ^{*3}		✓	✓	
	Dolby PLII Music/ Dolby PLIIx Music ^{*2}			✓ ^{*3}	✓ ^{*3}		✓	✓	
	Dolby PLII Game/ Dolby PLIIx Game ^{*2}				✓ ^{*3}			✓	
	Dolby Digital EX/Dolby EX			✓ ^{*3}			✓		
	Neo:6			✓ ^{*3}			✓		
	Neo:6 Cinema				✓ ^{*3}			✓	
Neo:6 Music				✓ ^{*3}			✓		
Neural THX 5.1				✓			✓		
Neural THX 7.1			✓	✓		✓	✓		
[THX]	THX Cinema ^{*2}	✓	✓			✓	✓		
	Dolby PLII/ Dolby PLIIx THX		✓	✓			✓	✓	
	Neo:6 THX		✓	✓			✓	✓	
	Dolby PLII THX Games Mode			✓				✓	
	Neo:6 THX Games Mode			✓				✓	
	THX Surround EX		✓				✓		
	THX Ultra2 Cinema		✓				✓		
	THX Music Mode		✓				✓		
	THX Games Mode		✓				✓		
Listening Mode [M]/[L]	Mono	✓ ^{*3}	✓ ^{*3}	✓ ^{*3}	✓ ^{*3}	✓	✓	✓	✓
	Onkyo Original DSP Mono Movie Orchestra Unplugged Studio-Mix TV Logic All Ch Stereo Full Mono T-D	✓	✓	✓	✓	✓	✓	✓	✓

*1. 192 kHz DTS-HD Master Audio sources are processed at 96 kHz.

*2. If there are no surround back speakers, or Powered Zone 2 is being used, Dolby Pro Logic II is used.

*3. Depending on the source (e.g., 96 kHz sources), processing may be performed after DTS decoding.

*4. Available only when using surround speakers.

■ Requires 6.1/7.1 speakers. Not available while Powered Zone 2 is being used.

■ Requires 7.1 speakers. Not available while Powered Zone 2 is being used.

About the Listening Modes

The AV receiver's listening modes can transform your listening room into a movie theater or concert hall, with high fidelity and stunning surround sound.

Direct

In this mode, audio from the input source is output directly with minimal processing, providing high-fidelity reproduction. All of the source's audio channels are output as they are.

Stereo

Sound is output by the front left and right speakers.

Mono

Use this mode when watching an old movie with a mono soundtrack, or use it with the foreign language soundtracks recorded in the left and right channels of some movies. It can also be used with DVDs or other sources containing multiplexed audio, such as karaoke DVDs.

Multichannel

This mode is for use with analog or PCM multichannel sources.

Dolby Pro Logic IIx

This mode expands any 2-channel source for 7.1-channel playback. It provides a very natural and seamless surround-sound experience that fully envelops the listener. As well as music and movies, video games can also benefit from the dramatic spatial effects and vivid imaging. If you're not using any surround back speakers, Dolby Pro Logic II will be used instead of Dolby Pro Logic IIx.

- **Dolby PLIIx Movie**

Use this mode with any stereo or Dolby Surround (Pro Logic) movie (e.g., TV, DVD, VHS).

- **Dolby PLIIx Music**

Use this mode with any stereo or Dolby Surround (Pro Logic) music source (e.g., CD, radio, cassette, TV, VHS, DVD).

- **Dolby PLIIx Game**

Use this mode with video games, especially those that bear the Dolby Pro Logic II logo.

Dolby Digital

Use this mode with DVDs that bear the Dolby Digital logo and Dolby Digital TV broadcasts. This is the most common digital surround-sound format, and it'll put you right in the middle of the action, just like being in a movie theater or concert hall.

Dolby EX

This mode expands 5.1-channel sources for 6.1/7.1-channel playback. It's especially suited to Dolby Digital EX soundtracks that include a matrix-encoded surround back channel. The additional channel adds an extra dimension and provides an enveloping surround sound experience, perfect for rotating and fly-by sound effects.

Dolby Digital Plus

Developed for use with HDTV, including the new video disc formats Blu-ray and HD DVD, this is the latest multichannel audio format from Dolby. It supports up to 7.1 channels with 48 kHz/24-bit sampling rate and signal resolution.

Dolby TrueHD

Designed to take full advantage of the additional storage space offered by the new Blu-ray and HD DVD disc formats, this new Dolby format offers up to 7.1 discrete channels of lossless audio performance with 96 kHz/24-bit sampling rate and signal resolution.

The AV receiver supports 7.1-channel sources up to 96 kHz and 2-channel sources up to 192 kHz.

DTS NEO:6

This mode expands any 2-channel source for 7.1-channel playback. It uses seven full-bandwidth channels of matrix decoding for matrix-encoded material, providing a very natural and seamless surround sound experience that fully envelops the listener.

- **NEO:6 Cinema**

Use this mode with any stereo movie (e.g., TV, DVD, VHS).

- **NEO:6 Music**

Use this mode with any stereo music source (e.g., CD, radio, cassette, TV, VHS, DVD).

DTS

The DTS digital surround-sound format supports up to 5.1 discrete channels and uses less compression for high-fidelity reproduction. Use it with DVDs and CDs that bear the DTS logo.

DTS 96/24

This mode is for use with DTS 96/24 sources. This is high-resolution DTS with a 96 kHz sampling rate and 24-bit resolution, providing superior fidelity. Use it with DVDs that bear the DTS 96/24 logo.

DTS-ES Discrete

This mode is for use with DTS-ES Discrete soundtracks that use a discrete surround-back channel for *true* 6.1/7.1-channel playback. The seven totally separate audio channels provide better spatial imaging and 360-degree sound localization, perfect for sounds that pan across the surround channels. Use it with DVDs that bear the DTS-ES logo, especially those with a DTS-ES Discrete soundtrack.

DTS-ES Matrix

This mode is for use with DTS-ES Matrix soundtracks that use a matrix-encoded back-channel for 6.1/7.1-channel playback. Use it with DVDs that bear the DTS-ES logo.

DTS-HD High Resolution

Developed for use with HDTV, including the new video disc formats Blu-ray and HD DVD, this is the latest multichannel audio format from DTS. It supports up to 7.1 channels with 96 kHz/24-bit sampling rate and signal resolution.

DTS-HD Master Audio

Designed to take full advantage of the additional storage space offered by the new Blu-ray and HD DVD disc formats, this new DTS format offers up to 7.1 discrete channels of uncompressed digital audio with 96 kHz/24-bit sampling rate and signal resolution.

The AV receiver supports 7.1-channel sources up to 96 kHz and 5.1-channel sources up to 192 kHz.

Neural THX 5.1/7.1

Neural-THX Surround employs psychoacoustic frequency domain processing, which allows delivery of a more detailed sound stage, with superior channel separation and localization of audio elements. The Neural THX 5.1 and Neural THX 7.1 modes can expand any 2-channel stereo source for 5.1- or 7.1-channel playback, respectively. Use them with CD, radio, cassette, TV, VHS, DVD, and other 2-channel stereo sources, including video games. Neural-THX Surround can also be used by broadcasters to encode and transmit surround-sound content over a stereo signal, which listeners can enjoy as either surround sound or normal stereo. XM Satellite Radio, for example, is using Neural-THX Surround on select channels, which the AV receiver can expand from 5.1 channels to 7.1 channels.

DSD

DSD stands for *Direct Stream Digital* and is the format used to store digital audio on Super Audio CDs (SACD). This mode can be used with SACDs that feature multi-channel audio.

THX

Founded by George Lucas, THX develops stringent standards that ensure movies are reproduced in movie theaters and home theaters just as the director intended.

- **THX Cinema**

This mode is for watching movies, which are typically recorded and edited on the assumption that they will be played in a sizable place like a movie theater. It carefully optimizes the tonal and spatial characteristics of the soundtrack for reproduction in the smaller home-theater environment. It can be used with 2-channel sources processed with other formats, and multichannel sources. Surround back speaker output depends on the source material and the selected listening mode.

- **THX Ultra2 Cinema**

This mode expands 5.1-channel sources for 7.1-channel playback. It does this by analyzing the composition of the surround source, optimizing the ambient and directional sounds to produce the surround back channel output.

- **THX Music Mode**

This mode is designed for use with music. It expands 5.1-channel sources for 7.1-channel playback.

- **THX Games Mode**

This mode is designed for use with video games. It can expand 2-channel and 5.1-channel sources for 6.1/7.1-channel playback.

- **THX Surround EX**

This mode expands 5.1-channel sources for 6.1/7.1-channel playback. It's especially suited to Dolby Digital EX sources. THX Surround EX, also known as Dolby Digital Surround EX, is a joint development between Dolby Laboratories and THX Ltd.

Onkyo Original DSP Modes

Mono Movie

This mode is suitable for old movies and other mono sources. The center speaker outputs the sound as it is, while reverb is applied to the sound output by the other speakers, giving presence to even mono material.

Orchestra

Suitable for classical or operatic music, this mode emphasizes the surround channels in order to widen the stereo image and simulates the natural reverberation of a large hall.

Unplugged

Suitable for acoustic instruments, vocals, and jazz, this mode emphasizes the front stereo image, giving the impression of being right in front of the stage.

Studio-Mix

Suitable for rock or pop music, listening to music in this mode creates a lively sound field with a powerful acoustic image, like being at a club or rock concert.

TV Logic

This mode adds realistic acoustics to TV shows produced in a TV studio, surround effects to the entire sound, and clarity to voices.

All Ch Stereo

Ideal for background music, this mode fills the entire listening area with stereo sound from the front, surround, and surround back speakers.

Full Mono

In this mode, all speakers output the same sound in mono, so the sound you hear is the same regardless of where you are within the listening room.

T-D (Theater-Dimensional)

With this mode, you can enjoy virtual 5.1 surround sound even with only two or three speakers. It works by controlling how sounds reach the listener's left and right ears. Good results may not be possible if there's too much reverb, so we recommend that you use this mode in an environment with little or no natural reverb.

Note:

- Since the Onkyo original DSP modes use the Dolby PLIIx and Neo:6 circuits for processing, when one of these modes is selected, the PLIIx indicator, or Neo:6 indicator for multichannel sources, lights up.

Recording

This section explains how to record the input source and how to record audio and video from separate sources.

Notes:

- The surround sound and DSP listening modes cannot be recorded.
- Copy-protected DVDs cannot be recorded.
- Sources connected to the analog multichannel input cannot be recorded.
- Various restrictions apply to digital recording. Refer to the manuals supplied with your digital recording equipment for more details.
- Digital input signals are output by only the digital outputs, and analog input signals are output by only the analog outputs. There is no internal conversion from digital to analog or vice versa.
- DTS signals will be recorded as noise, so don't attempt analog recording of DTS CDs or LDs.

Recording the Input Source

Audio sources can be recorded to a recorder (e.g., cassette deck, CDR, MD) connected to the TAPE OUT or DIGITAL OPTICAL OUT jacks. Video sources can be recorded to a video recorder (e.g., VCR, DVR) connected to the VCR/DVR OUT jacks. See pages 26 to 42 for hookup information.

1

Remote controller

Use the input selector buttons to select the source that you want to record.

See “Which Connections Should I Use?” on page 27 to see which signals can be output and recorded.

You can watch the source while recording it. The AV receiver's Master Volume control has no effect on recording.

2

On your recorder, start recording.

3

On the source component, start playback.

Note:

- If you select a different input source during recording, that input source will be recorded instead.

Recording from Different AV Sources

You can overdub audio onto your video recordings by simultaneously recording audio and video from two separate sources. This is possible because only the audio source is switched when an audio-only input source, such as TAPE, TUNER, or CD, is selected, the video source remains the same.

In the following example, audio from the CD player connected to the CD IN and video from the camcorder connected to the AUX 2 INPUT VIDEO jack are recorded by the VCR connected to the VCR/DVR OUT jacks.

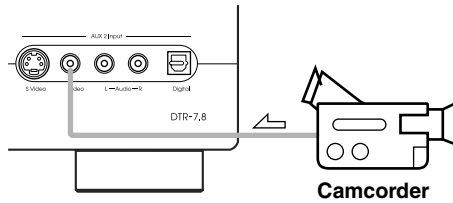

↗ : video signal
 ↘ : audio signal

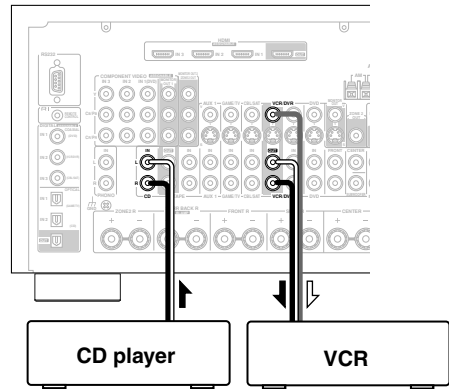

- 1** Prepare the camcorder and CD player for playback.
- 2** Prepare the VCR for recording.
- 3** Press the [AUX 2] input selector button.
- 4** Press the [CD] input selector button. This selects the CD player as the audio source but leaves the camcorder as the video source.
- 5** Start recording on the VCR, then start playback on the camcorder and CD player. Video from the camcorder and audio from the CD player are recorded by the VCR.

Onscreen Setup Menus

The onscreen setup menus appear on the connected TV and provide a convenient way to change the AV receiver's various settings. Settings are organized into eight categories on the **main menu**, most containing a **submenu**.

Menu
1. Input/Output Assign
2. Speaker Setup
3. Audio Adjust
4. Source Setup
5. Listening Mode Preset
6. Miscellaneous
7. Hardware Setup
8. Lock Setup

Menu Map

The following map shows how the setup menus are organized. Use the page numbers to locate information about items.

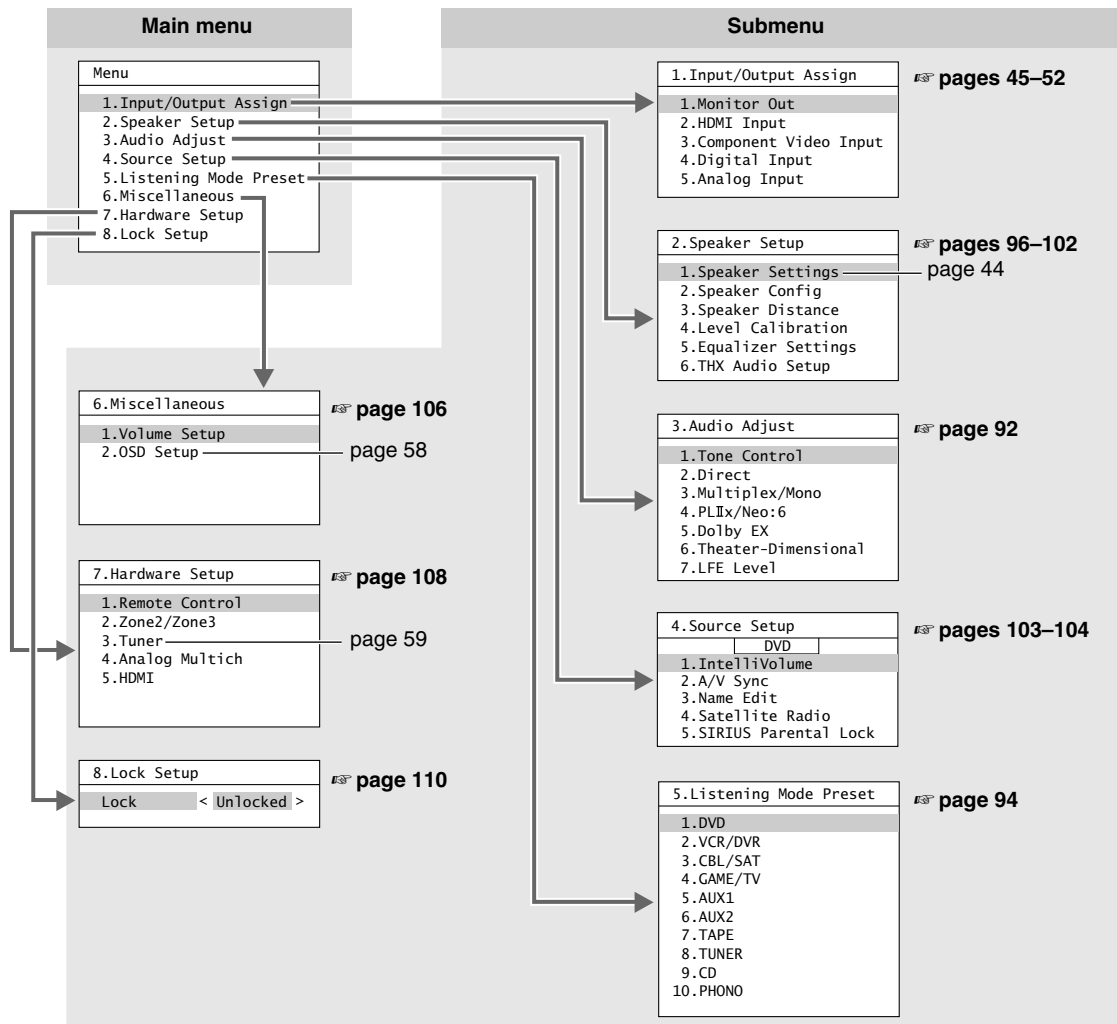

Adjusting the Listening Modes

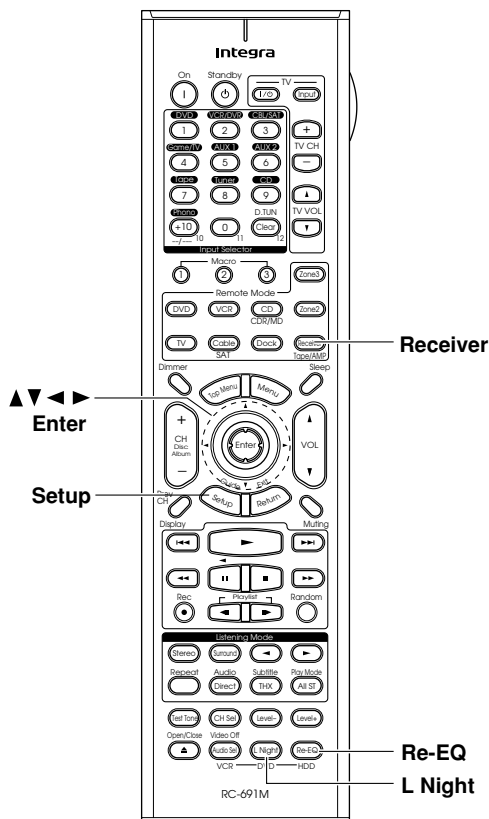

Using the Re-EQ Function

With the Re-EQ function, you can compensate a soundtrack whose high-frequency content is too harsh, making it more suitable for home theater viewing.

This function can be used with the following listening modes: Dolby Digital, Dolby Digital EX, Dolby Pro Logic II Movie, Dolby Pro Logic IIx Movie, DTS, DTS-ES, DTS Neo:6 Cinema, DTS 96/24, THX Cinema, THX Surround EX, THX Ultra2 Cinema, and Multi-channel.



Press the [Receiver] Remote Mode button, followed by the [Re-EQ] button.

Press the [Re-EQ] button again to turn off the Re-EQ function.

Using the Late Night Function

With the Late Night function, you can reduce the dynamic range of Dolby Digital material so that you can still hear quiet parts even when listening at low volume levels—ideal for watching movies late at night when you don't want to disturb anyone.



Press the [Receiver] Remote Mode button, and then press the [L Night] button repeatedly.

For Dolby Digital and Dolby Digital Plus sources, the options are:

- Off:** Late Night function off (default).
- Low:** Small reduction in dynamic range.
- High:** Large reduction in dynamic range.

For Dolby TrueHD sources, the options are:





- Auto:** The dynamic range is controlled automatically based on the source material and the current volume setting (default).
- Off:** Late Night function off.
- On:** Late Night function on.

Notes:

- The Late Night function can be used only when the input source is Dolby Digital, Dolby Digital Plus, or Dolby TrueHD.
- The effect of the Late Night function depends on the material that you are playing and the intention of the original sound designer, and with some material there will be little or no effect when you select the different options.
- The Late Night function is set to Off when the AV receiver is set to Standby. For Dolby TrueHD sources, it will be set to Auto.

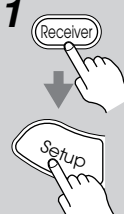
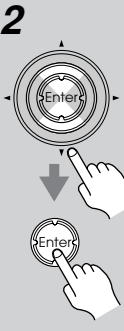
Audio Adjust

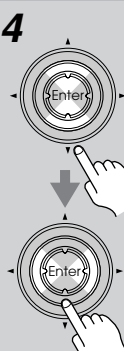
With the Audio Adjust functions and settings, you can adjust the sound and listening modes as you like.

<p>1</p> 	<p>Press the [Receiver] Remote Mode button, followed by the [Setup] button. The main menu appears onscreen.</p>								
<p>2</p> 	<p>Use the Up and Down [▲]/[▼] buttons to select “3. Audio Adjust,” and then press [Enter]. The Audio Adjust menu appears.</p> <table border="1" data-bbox="294 695 637 879"> <tr><td>3. Audio Adjust</td></tr> <tr><td>1. Tone Control</td></tr> <tr><td>2. Direct</td></tr> <tr><td>3. Multiplex/Mono</td></tr> <tr><td>4. PLIX/Neo:6</td></tr> <tr><td>5. Dolby EX</td></tr> <tr><td>6. Theater-Dimensional</td></tr> <tr><td>7. LFE Level</td></tr> </table>	3. Audio Adjust	1. Tone Control	2. Direct	3. Multiplex/Mono	4. PLIX/Neo:6	5. Dolby EX	6. Theater-Dimensional	7. LFE Level
3. Audio Adjust									
1. Tone Control									
2. Direct									
3. Multiplex/Mono									
4. PLIX/Neo:6									
5. Dolby EX									
6. Theater-Dimensional									
7. LFE Level									
<p>3</p> 	<p>Use the Up and Down [▲]/[▼] buttons to select an item, and then press [Enter]. The screen for that item appears.</p>								
<p>4</p> 	<p>Use the Up and Down [▲]/[▼] buttons to select an option, and use the Left and Right [◀]/[▶] buttons to change it. The Audio Adjust menu items are explained below.</p>								
<p>5</p> 	<p>When you've finished, press the [Setup] button. Setup closes.</p>								

Tone Control Settings

You can adjust the tone (bass and treble) of the front, center, surround, and surround back speakers individually. For the subwoofer, you can adjust the bass.

■ Bass

You can boost or cut low-frequency sounds from -10 dB to +10 dB in 1 dB steps.

■ Treble

You can boost or cut high-frequency sounds from -10 dB to +10 dB in 1 dB steps.

Note:

- The tone control circuits are bypassed when the Direct listening mode is selected.

Adjusting the Tone on the AV Receiver

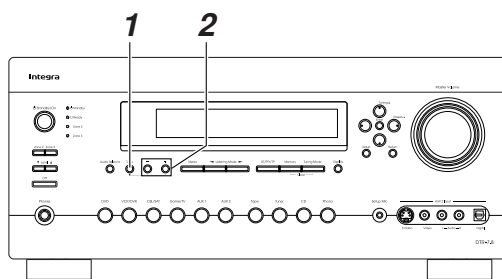

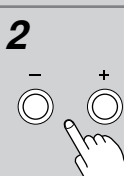
<p>1</p> 	<p>Press the AV receiver's [Tone] button repeatedly to select Bass or Treble for Front, Center, Surround, SurrBack, or Subwoofer.</p>
<p>2</p> 	<p>Use the Tone Plus [+] and Minus [-] buttons to adjust.</p>

Notes:

- The tone cannot be adjusted on the AV receiver when the Direct listening mode is selected.
- The tone control settings do not apply to the THX listening modes.

Direct Setting

Delay Enable

■ DSD

This setting determines whether or not DSD (SACD) audio signals are passed through the DSP for A/V Sync, delay, etc., processing when the Direct listening mode is selected.

No: DSD signals are not processed by the DSP.

Yes: DSD signals are processed by the DSP.

Multiplex/Mono Settings

Multiplex

■ Input Ch

This setting determines which channel of a stereo multiplex source is output. Use it to select audio channels or languages with multiplex sources, multilingual TV broadcasts, and so on.

Main: The main channel is output (default).

Sub: The sub channel is output.

Main/Sub: Both the main and sub channels are output.

Mono

■ Input Ch

This setting determines which channel is output when the Mono listening mode is used with a stereo source.

L+R: Both the left and right channels are output (default).

L: Only the left channel is output.

R: Only the right channel is output.

■ Output Speaker

This setting determines which speakers output mono audio when the Mono listening mode is selected.

L/R: Mono audio is output by the front left and right speakers.

C: Mono audio is output by the center speaker (default).

PLIIx/Neo:6 Settings

PLIIx Music (2 ch Input)

These settings apply to only 2-channel stereo sources.

If you're not using any surround back speakers, these settings apply to Dolby Pro Logic II, not Dolby Pro Logic IIx.

■ Panorama

With this setting, you can broaden the width of the front stereo image when using the Dolby Pro Logic IIx Music listening mode.

On: Panorama function on.

Off: Panorama function off (default).

■ Dimension

With this setting, you can move the sound field forward or backward when using the Dolby Pro Logic IIx Music listening mode. It can be adjusted from -3 to +3. The default value is 0. Higher settings move the sound field forward. Lower settings move it backward.

If the stereo image feels too wide, or there's too much surround sound, move the sound field forward to improve the balance. Conversely, if the stereo image feels like it's in mono, or there's not enough surround sound, move it backward.

■ Center Width

With this setting, you can adjust the width of the sound from the center speaker when using the Dolby Pro Logic IIx Music listening mode. Normally, if you're using a center speaker, the center channel sound is output by only the center speaker. (If you're not using a center speaker, the center channel sound will be distributed to the front left and right speakers to create a phantom center). This setting controls the front left, right, and center mix, allowing you to adjust the weight of the center channel sound. It can be adjusted from 0 to 7. The default value is 3.

Neo:6 Music

■ Center Image

The DTS Neo:6 Music listening mode creates 6-channel surround sound from 2-channel stereo sources. With this setting, you can specify by how much the front left and right channel output is attenuated in order to create the center channel. It can be adjusted from 0 to 5. The default value is 3.

When set to 0, the front left and right channel output is attenuated by half (-6 dB), giving the impression that the sound is located centrally. This setting works well when the listening position is considerably off center. When set to 5, the front left and right channels are not attenuated, maintaining the original stereo balance.

Adjusting the Listening Modes—Continued

Dolby Digital Settings

■ Dolby EX

This setting determines how Dolby EX signals are handled.

Auto: When the source is Dolby EX, you can select the Dolby EX or THX Surround EX listening mode.

Manual: When the source is Dolby EX, you can select any of the listening modes compatible with this format (e.g., Dolby EX, Dolby Pro Logic IIX, etc.).

T-D (Theater-Dimensional) Setting

■ Listening Angle

With this setting, you can optimize the Theater-Dimensional listening mode by specifying the angle of the front left and right speakers relative to the listening position. Ideally, the front left and right speakers should be equidistant from the listening position and at an angle close to one of the two available settings.

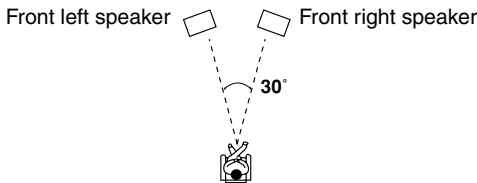

Narrow: Select if the angle is less than 30 degrees.

Wide: Select if the angle is greater than 30 degrees.

LFE Level Settings

With these settings, you can set the level of the LFE (Low Frequency Effects) channel individually for Dolby Digital, DTS, and multichannel PCM sources. The level can be set to $-\infty$, -20 dB, -10 dB, or 0 dB (default).

If you find that low-frequency effects are too loud when using one of these sources, change the setting to -20 dB or $-\infty$ dB.

■ Dolby D

Sets the level of the LFE channel for Dolby Digital sources.

■ DTS

Sets the level of the LFE channel for DTS sources.

■ Dolby TrueHD

Sets the level of the LFE channel for Dolby TrueHD sources.

■ DTS-HD Master Audio

Sets the level of the LFE channel for DTS-HD Master Audio sources.

■ DSD

Sets the level of the LFE channel for DSD sources.

■ Multich PCM

Sets the level of the LFE channel for multichannel PCM sources. (Multichannel PCM is input via HDMI.)

Listening Mode Presets

On the Listening Mode Preset menu, you can specify a default listening mode for each of the audio formats supported by each input selector. The AV receiver will then select the listening mode automatically depending on the format of the input signal. You can still select the other listening modes, although the default listening mode will be used the next time you turn on the AV receiver.

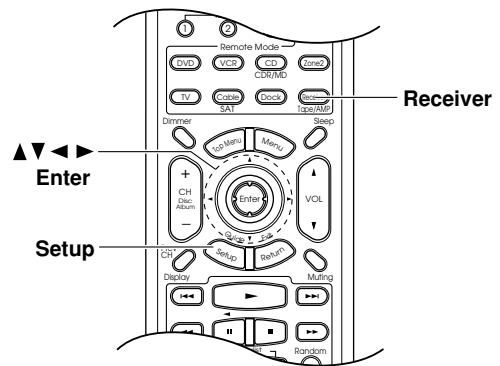

1 Press the [Receiver] Remote Mode button, followed by the [Setup] button.

The main menu appears onscreen.

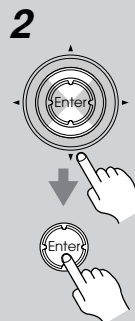

2 Use the Up and Down [\blacktriangle]/[\blacktriangledown] buttons to select "5. Listening Mode Preset," and then press [Enter].

The Listening Mode Preset menu appears.

5. Listening Mode Preset	
1.	DVD
2.	VCR/DVR
3.	CBL/SAT
4.	GAME/TV
5.	AUX1
6.	AUX2
7.	TAPE
8.	TUNER
9.	CD
10.	PHONO

3

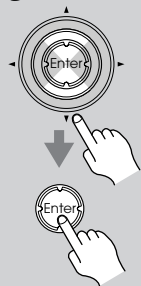

Use the Up and Down [▲]/[▼] buttons to select an input selector, and then press [Enter].

The audio formats supported by that input selector appear.

5-x.Listening Mode Preset	
Analog/PCM	◀ Last Valid ▶ ▲
Dolby Digital	Last Valid
DTS	Last Valid
D.F.2ch	Last Valid
D.F.Mono	Last Valid ▼

If the input selector is assigned to an HDMI IN, use the Down [▼] button to select the audio formats shown on the following screen.

5-x.Listening Mode Preset	
Multich PCM	◀ Last Valid ▶ ▲
192k/176.4k	Last Valid
Dolby True HD	Last Valid
DTS-HD Master Audio	Last Valid
DSD	Last Valid ▼

For the TUNER input selector, Analog is the only format available.

4

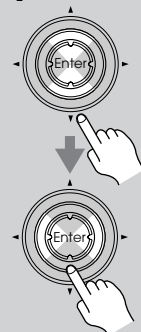

Use the Up and Down [▲]/[▼] buttons to select an audio format, and use the Left and Right [◀]/[▶] buttons to select a listening mode.

Only listening modes compatible with the audio format can be selected (see page 83).

Analog/PCM: Specifies the default listening mode for analog and PCM sources.

Dolby Digital: Specifies the default listening mode for Dolby Digital sources.

DTS: Specifies the default listening mode for DTS sources.

D.F. 2ch: Specifies the default listening mode for 2-channel (2/0) stereo sources in a digital format, such as Dolby Digital or DTS.

D.F. Mono: Specifies the default listening mode for mono sources in a digital format, such as Dolby Digital or DTS.

Multich PCM: Specifies the default listening mode for multichannel PCM sources, such as DVD-Audio (input via HDMI).

192/176.4k: Specifies the default listening mode for high resolution 192 kHz and 176.4 kHz digital sources, such as DVD-Audio.

Dolby TrueHD: Specifies the default listening mode for Dolby TrueHD sources, such as Blu-ray or HD DVD (input via HDMI).

DTS-HD Master Audio: Specifies the default listening mode for DTS-HD Master Audio sources, such as Blu-ray or HD DVD (input via HDMI).

DSD Multi: Specifies the default listening mode for DSD multichannel sources, such as SACD.

5



When you've finished, press the [Setup] button.

Setup closes.

Note:

- This procedure can also be performed on the AV receiver by using its [Setup], [Enter], and arrow buttons.

Advanced Setup

Speaker Setup

This section explains items on the Speaker Config menu. Some of the speaker settings are set automatically by the Automatic Speaker Setup function (see page 53).

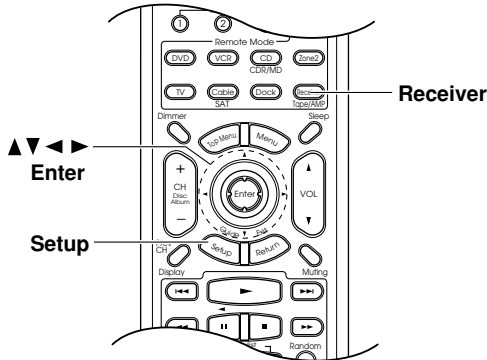

Speaker Settings

See “Speaker Settings” on page 44.

Speaker Configuration

These settings are set automatically by the Automatic Speaker Setup function (see page 53).

With the Speaker Configuration settings, you can specify which speakers are connected and a crossover frequency for each speaker.

The following crossover frequencies can be specified: Full Band, 40 Hz, 45 Hz, 50 Hz, 55 Hz, 60 Hz, 70 Hz, 80 Hz (THX), 90 Hz, 100 Hz, 110 Hz, 120 Hz, 130 Hz, 150 Hz, or 200 Hz.

Specify Full Band for speakers that can output low-frequency bass sounds adequately, for example, speakers with a good sized woofer. For smaller speakers, specify a crossover frequency. Sounds below the crossover frequency will then be output by the subwoofer instead of the speaker. Refer to your speakers’ manuals to determine the optimum crossover frequencies.

If you’re using THX-certified speakers, specify 80 Hz (THX) for all speakers.

1 Press the [Receiver] Remote Mode button, followed by the [Setup] button.
The main menu appears onscreen.

2 Use the Up and Down [▲]/[▼] buttons to select “2. Speaker Setup,” and then press [Enter].
The Speaker Setup menu appears.

2. Speaker Setup	
1. Speaker Settings	
2. Speaker Config	
3. Speaker Distance	
4. Level Calibration	
5. Equalizer Settings	
6. THX Audio Setup	

3 Use the Up and Down [▲]/[▼] buttons to select “2. Speaker Config,” and then press [Enter].
The Speaker Config screen appears.

2-2. Speaker Config	
Subwoofer	Yes
Front	Full Band
Center	100Hz
Surround	100Hz
Surr Back	100Hz
Surr Back Ch	2ch
LPF of LFE	120Hz
Double Bass	On

4 Use the Up and Down [▲]/[▼] buttons to select “Subwoofer,” and then use the Left and Right [◀]/[▶] buttons to select:

Yes: Select if a subwoofer is connected.

No: Select if no subwoofer is connected.

5

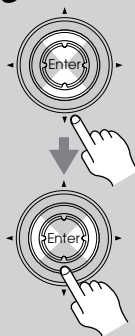

Use the Up and Down [▲]/[▼] buttons to select “Front,” and then use the Left and Right [◀]/[▶] buttons to select a crossover frequency.

Note:

- Fixed at Full Band if Subwoofer (step 4) is set to No.

6

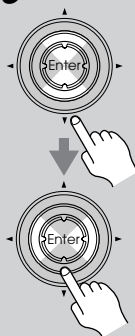

Use the Up and Down [▲]/[▼] buttons to select “Center,” and then use the Left and Right [◀]/[▶] buttons to select a crossover frequency.

If no center speaker is connected, select None.

Note:

- Cannot select Full Band if Front (step 5) is set to anything other than Full Band.

7

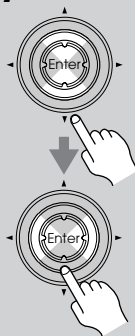

Use the Up and Down [▲]/[▼] buttons to select “Surround,” and then use the Left and Right [◀]/[▶] buttons to select a crossover frequency.

If no surround left and right speakers are connected, select None.

Note:

- Cannot select Full Band if Front (step 5) is set to anything other than Full Band.

8

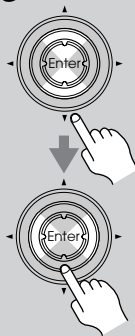

Use the Up and Down [▲]/[▼] buttons to select “Surr Back,” and then use the Left and Right [◀]/[▶] buttons to select a crossover frequency.

If no surround back speakers are connected, select None.

Notes:

- Cannot be set if Speaker Type is set to Bi-Amp (page 44), Surround is set to None (step 7), or Powered Zone 2 is being used (page 113).
- Cannot select Full Band if Surround (step 7) is set to anything other than Full Band.

9

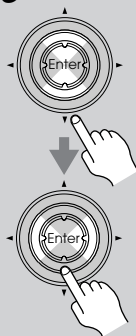

Use the Up and Down [▲]/[▼] buttons to select “Surr Back Ch,” and then use the Left and Right [◀]/[▶] buttons to select:

1ch: Select if one surround back speaker is connected.

2ch: Select if two (left and right) surround back speakers are connected.

Note:

- Cannot be set if Speaker Type is set to Bi-Amp (page 44), SurrBack is set to None (step 8), or Powered Zone 2 is being used (page 113).

Continue with step 10 on the next page.

Low-Pass Filter for the LFE Channel

This setting is *not* set automatically by the Automatic Speaker Setup function (see page 53).

With this setting, you can specify the cutoff frequency of the LFE channel's low-pass filter (LPF), which can be used to filter out unwanted hum. The LPF only applies to sources that use the LFE channel.

*If you're using THX-certified speakers, select 80 Hz (THX).

10

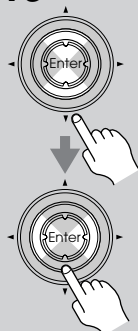

Use the Up and Down [▲]/[▼] buttons to select “LPF of LFE,” and then use the Left and Right [◀]/[▶] buttons to select a low-pass filter frequency.

The following low-pass filter frequencies can be selected: 80 Hz (THX), 90 Hz, 100 Hz, 110 Hz, or 120 Hz.

Continue with step 11 in the next column.

Double Bass

This setting is *not* set automatically by the Automatic Speaker Setup function (see page 53).

With this setting, you can boost bass output by feeding front left and right channel bass sounds to the subwoofer. This setting can only be made if the Subwoofer setting in step 4 is set to Yes, and the Front setting in step 5 is set to Full Band.

*If you're using THX-certified speakers, select Off (THX).

11

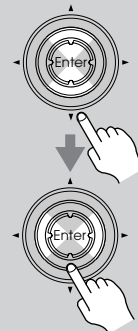

Use the Up and Down [▲]/[▼] buttons to select “Double Bass,” and then use the Left and Right [◀]/[▶] buttons to select:

Off (THX): The subwoofer only outputs the LFE channel.

On: In addition to LFE channel sounds, the subwoofer outputs front left and right channel bass sounds.

12



Press the [Setup] button.
Setup closes.

Note:

- This procedure can also be performed on the AV receiver by using its [Setup], [Enter], and arrow buttons.

Speaker Distance

These settings are set automatically by the Automatic Speaker Setup function (see page 53).

With the Speaker Distance settings, you can specify the distance from each speaker to the listening position.

1 Press the [Receiver] Remote Mode button, followed by the [Setup] button.
The main menu appears onscreen.



2 Use the Up and Down [▲]/[▼] buttons to select “2. Speaker Setup,” and then press [Enter].
The Speaker Setup menu appears.

2. Speaker Setup	
1. Speaker Settings	
2. Speaker Config	
3. Speaker Distance	
4. Level Calibration	
5. Equalizer Settings	
6. THX Audio Setup	

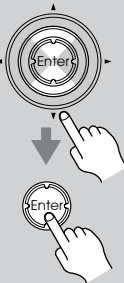

3 Use the Up and Down [▲]/[▼] buttons to select “3. Speaker Distance,” and then press [Enter].
The Speaker Distance screen appears.

2-3. Speaker Distance	
Unit	◀ feet ▶
Left	12.0ft
Center	12.0ft
Right	12.0ft
Surr Right	12.0ft
Surr Back R	12.0ft
Surr Back L	12.0ft
Surr Left	12.0ft
Subwoofer	12.0ft

Note:

- Speakers that you set to No or None in the Speaker Configuration (page 96) cannot be selected.



4 Use the Up and Down [▲]/[▼] buttons to select “Unit,” and then use the Left and Right [◀]/[▶] buttons to select:

feet: Select if you want to enter distances in feet. Can be set from 0.2 to 30 feet in 0.2-foot steps.

meters: Select if you want to enter distances in meters. Can be set from 0.06 to 9 meters in 0.06-meter steps.

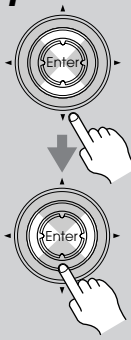

5 Use the Up and Down [▲]/[▼] buttons to select a speaker, and use the Left and Right [◀]/[▶] buttons to specify the distance. Specify the distance from the speaker to your listening position.

Notes:

- The Center distance cannot be set if Center is set to None in the Speaker Configuration (page 96).
- The Surr Right and Surr Left distances cannot be set if Surround is set to None in the Speaker Configuration (page 96).
- The Surr Back R and Surr Back L distances cannot be set if Speaker Type is set to Bi-Amp (page 44), Surr Back is set to None in the Speaker Configuration (page 96), or Powered Zone 2 is being used (page 113).
- The Subwoofer distance cannot be set if Subwoofer is set to No (step 4).



6 Repeat step 5 for each speaker.

7 Press the [Setup] button.
Setup closes.



Note:

- This procedure can also be performed on the AV receiver by using its [Setup], [Enter], and arrow buttons.

Speaker Level Calibration

These settings are set automatically by the Automatic Speaker Setup function (see page 53).

With the Level Calibration settings, you can adjust the level of each speaker while listening to the test tone so that the volume of each speaker is the same at the listening position.

Note:

- The test tone is output at the standard level for THX, which is 0 dB (absolute volume setting 82). If you normally listen at volume settings below this, be careful because the test tone will be much louder.

1 Press the [Receiver] Remote Mode button, followed by the [Setup] button.
The main menu appears onscreen.

2 Use the Up and Down [▲]/[▼] buttons to select “2. Speaker Setup,” and then press [Enter].
The Speaker Setup menu appears.

2. Speaker Setup	
1. Speaker Settings	
2. Speaker Config	
3. Speaker Distance	
4. Level Calibration	
5. Equalizer Settings	
6. THX Audio Setup	

3 Use the Up and Down [▲]/[▼] buttons to select “4. Level Calibration,” and then press [Enter].
The Level Calibration screen appears and the pink noise test tone is output by the front left speaker.

2-4. Level Calibration	
Left	◀ -12.0dB ▶
Center	-12.0dB
Right	-12.0dB
Surr Right	-12.0dB
Surr Back R	-12.0dB
Surr Back L	-12.0dB
Surr Left	-12.0dB
Subwoofer	-15.0dB

Note:

- Levels cannot be adjusted for speakers set to No or None in the Speaker Configuration (page 96).

4 Use the Up and Down [▲]/[▼] buttons to select a speaker, and use the Left and Right [◀]/[▶] buttons to adjust the level.
Levels can be adjusted from -12 to +12 dB in 0.5 dB steps (-15 to +12 dB for the subwoofer).

5 Repeat step 4 for each speaker so that the volume of the test tone from each speaker is the same.
If you're using a handheld sound level meter, adjust the level of each speaker so that it reads 75 dB SPL at the listening position, measured with C-weighting and slow reading.

6 Press the [Setup] button.
Setup closes.

Note:

- Speaker levels can also be adjusted by using the dedicated buttons on the remote controller. Press the [Test Tone] button to output the test tone. Use the [CH Sel] button to select each speaker, and use the [Level-] and [Level+] buttons to adjust the level.

Equalizer Settings

These settings are set automatically by the Automatic Speaker Setup function (see page 53).

With the Equalizer settings, you can adjust the tone of speakers individually with a 15-band equalizer. The volume of each speaker can be set on page 100.

1 Press the [Receiver] Remote Mode button, followed by the [Setup] button.
The main menu appears onscreen.

2 Use the Up and Down [▲]/[▼] buttons to select “2. Speaker Setup,” and then press [Enter].
The Speaker Setup menu appears.

2. Speaker Setup	
1. Speaker Settings	
2. Speaker Config	
3. Speaker Distance	
4. Level Calibration	
5. Equalizer Settings	
6. THX Audio Setup	

3 Use the Up and Down [▲]/[▼] buttons to select “5. Equalizer Settings,” and then press [Enter].
The Equalizer Settings screen appears.
Use the Up and Down [▲]/[▼] buttons move between the two screens.

2-5. Equalizer Settings		
Equalizer		◀ Manual ▶
Channel		Front
25Hz		0dB
40Hz		0dB
63Hz		0dB
100Hz		0dB
160Hz		0dB
250Hz		0dB
400Hz		0dB

2-5. Equalizer Settings	
630Hz	0dB
1000Hz	0dB
1600Hz	0dB
2500Hz	0dB
4000Hz	0dB
6300Hz	0dB
10000Hz	0dB
16000Hz	0dB

4 Use the Left and Right [◀]/[▶] buttons to set the “Equalizer” option to:
Off: Equalizer off, flat response.
Manual: The equalizer for each speaker can be set manually.
Audyssey: The equalizer for each speaker is set automatically by the Automatic Speaker Setup function.
If you selected Manual, continue with the next step. If you selected Off or Audyssey, go to step 8.

5 Use the Down [▼] button to select “Channel,” and then use the Left and Right [◀]/[▶] buttons to select the speaker.
You can select: Front, Center, Surround, Surr Back, or Subwoofer.

6 Use the Up and Down [▲]/[▼] buttons to select a frequency, and use the Left and Right [◀]/[▶] buttons to cut or boost that frequency.
You can select: 25 Hz, 40 Hz, 63 Hz, 100 Hz, 160 Hz, 250 Hz, 400 Hz, 630 Hz, 1000 Hz, 1600 Hz, 2500 Hz, 4000 Hz, 6300 Hz, 10000 Hz, or 16000 Hz. And for the subwoofer, 25 Hz, 40 Hz, 63 Hz, 100 Hz, or 160 Hz.
Each band can be cut or boosted from -6 dB to +6 dB in 1 dB steps.
Tip: Low frequencies, such as 160 Hz, affect bass sounds; high frequencies, such as 6300 Hz, affect treble sounds.

7 Use the Up [▲] button to select “Channel” again, and use the Left and Right [◀]/[▶] buttons to select another speaker. Repeat steps 6 and 7 for each speaker.

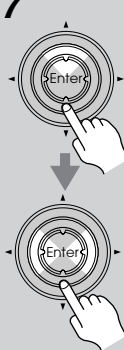

8 Press the [Setup] button. Setup closes.



Notes:

- This procedure can also be performed on the AV receiver by using its [Setup], [Enter], and arrow buttons.
- The Equalizer settings have no effect on 176.4/192 kHz input signals.

THX Audio Setup

These settings are *not* set automatically by the Automatic Speaker Setup function (see page 53).

With the Surr Back Sp Spacing, you can specify the distance between your surround back speakers.

If you're using a THX-certified subwoofer, set the THX Subwoofer setting to Yes. You can then apply THX's Boundary Gain Compensation (BGC) to compensate the perceived exaggeration of low frequencies for listeners sitting very close to a room boundary (i.e., wall).

1 Press the [Receiver] Remote Mode button, followed by the [Setup] button. The main menu appears onscreen.



2 Use the Up and Down [▲]/[▼] buttons to select “2. Speaker Setup,” and then press [Enter]. The Speaker Setup menu appears.



2. Speaker Setup	
1. Speaker Settings	
2. Speaker Config	
3. Speaker Distance	
4. Level Calibration	
5. Equalizer Settings	
6. THX Audio Setup	

3 Use the Up and Down [▲]/[▼] buttons to select “6. THX Audio Setup,” and then press [Enter]. The THX Audio Setup screen appears.



2-6. THX Audio Setup	
Surr Back Sp Spacing	◀ 1ft-4ft ▶
THX Subwoofer	Yes
BGC	Off

4 Use the Up and Down [▲]/[▼] buttons to select “Surr Back Sp Spacing,” and use the Left and Right [◀]/[▶] buttons to specify the distance between your surround back speakers:

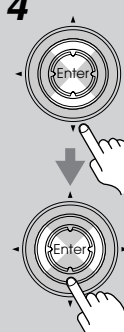

< 1 ft (< 0.3 m) (Default): Select this if your surround back speakers are between 0 and 1 foot (0–30 cm) apart.

1–4 ft (0.3–1.2 m): Select this if your surround back speakers are between 1 and 4 feet (0.3–1.2 m) apart.

>4 ft (>1.2 m): Select this if your surround back speakers are more than 4 feet (1.2 m) apart.

Note:

- This setting is only available if the Surr Back Ch setting in the Speaker Configuration is set to 2ch (page 97).

5 Use the Up and Down [▲]/[▼] buttons to select “THX Subwoofer,” and use the Left and Right [◀]/[▶] buttons to select:

No: Select this if you do not have a THX-certified subwoofer.

Yes: Select this if you have a THX-certified subwoofer.

6 Use the Up and Down [▲]/[▼] buttons to select “BGC,” and use the Left and Right [◀]/[▶] buttons to select:

Off: Select this to turn off BGC.

On: Select this to turn on BGC.

Note:

- This setting is only available if THX Subwoofer is set to Yes (step 5).

7 Press the [Setup] button. The setup menu closes.

Note:

- This procedure can also be performed on the AV receiver by using its [Setup], [Enter], and arrow buttons.

Source Setup

This section explains items on the Source Setup menu. Items can be set individually for each input selector.

1 Press the [Receiver] Remote Mode button, and then use the input selector buttons to select an input source.

2 Press the [Setup] button. The main menu appears onscreen.

3 Use the Up and Down [▲]/[▼] buttons to select “4. Source Setup,” and then press [Enter]. The Source Setup menu appears. The name of the currently selected input selector is displayed in a box.

4. Source Setup	
	DVD
1.	IntelliVolume
2.	A/V Sync
3.	Name Edit
4.	Satellite Radio
5.	SIRIUS Parental Lock

4 Use the Up and Down [▲]/[▼] buttons to select an item, and then press [Enter]. The screen for that item appears.

5 Use the Up and Down [▲]/[▼] buttons to select an option, and use the Left and Right [◀]/[▶] buttons to change it. The Source Setup menu items are explained below.

6



When you've finished, press the [Setup] button. Setup closes.

IntelliVolume

With IntelliVolume, you can set the input level for each input selector individually. This is useful if one of your source components is louder or quieter than the others.

Use the Up and Down [▲]/[▼] buttons to select an input selector, and use the Left and Right [◀]/[▶] buttons to set the level.

If a component is noticeably louder than the others, use the Left [◀] button to reduce its input level. If it's noticeably quieter, use the Right [▶] button to increase its input level. The input level can be adjusted from -12 dB to +12 dB in 1 dB steps.

Note:

- IntelliVolume does not apply for Zone 2 or Zone 3.

A/V Sync

When using your DVD player's progressive scanning function, you may find that the picture and sound are out of sync. With the A/V Sync setting, you can correct this by applying a delay to the audio signal. The delay can be set from 0 to 250 milliseconds (msec) in 5 millisecond steps.

Use the Up and Down [▲]/[▼] buttons to select an input selector, and use the Left and Right [◀]/[▶] buttons to set the delay.

To view the TV picture while setting the delay, press [Enter].

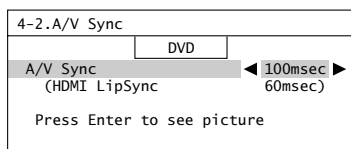

If HDMI Lip Sync is enabled (see page 109), and your TV or display supports HDMI Lip Sync, the displayed delay time will be the A/V Sync delay time. The HDMI Lip Sync delay time is displayed underneath in parentheses.

Note:

- A/V Sync cannot be set when the Direct listening mode is used with an analog input source.

Name Edit

You can enter a custom name for each individual input selector and radio preset for easy identification. When selected, the custom name will appear on the display.

1

Select the input selector to which you want to give a custom name.

To name a radio preset, use the [Tuner] button to select AM or FM, and then select the preset.

2

Press the [Receiver] Remote Mode button, followed by the [Setup] button.



3

Use the Up and Down [▲]/[▼] buttons to select "4. Source Setup," and then press [Enter]. The Source Setup menu appears.

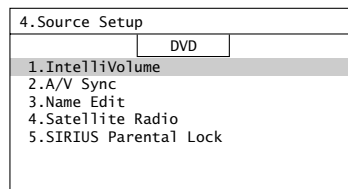
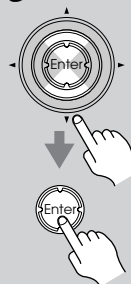

4

Use the Up and Down [▲]/[▼] buttons to select "Name Edit," and then press [Enter]. The Name Edit screen appears.

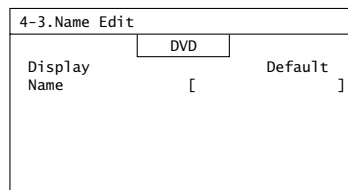
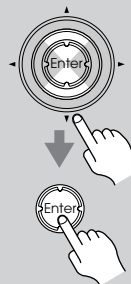

If you're naming an item for the very first time, go to step 6.

If the item already has a name, you can select Default or Custom in step 5.

5

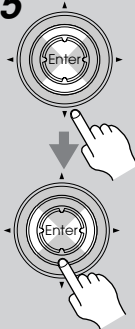

Use the Up and Down [▲]/[▼] buttons to select “Display,” and use the Left and Right [◀]/[▶] buttons to select:

Default: The default name is displayed.

Custom: The custom name is displayed.

When Default is selected, the station’s frequency appears on the display when a radio preset is selected.

6

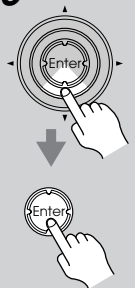

Press the Down [▼] button to select “Name,” and then press [Enter] to open the character input screen.

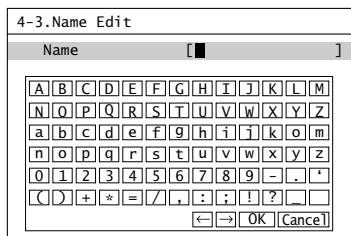

7



Use the arrow [▲]/[▼]/[◀]/[▶] buttons to select a character, and then press [Enter].

Repeat this step to enter up to 10 characters.

To correct a character:

1. Use the arrow [▲]/[▼]/[◀]/[▶] buttons to select the incorrect character, and then press [Enter]. The character input screen opens.
2. Use the arrow [▲]/[▼]/[◀]/[▶] buttons to select the correct character, and then press [Enter].

8



When you’ve finished, use the arrow [▲]/[▼]/[◀]/[▶] buttons to display the following screen, select “OK,” and then press [Enter].

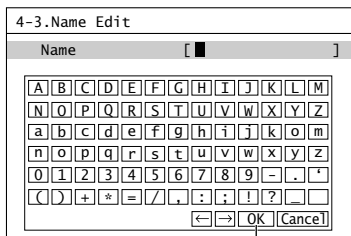

“OK”

9



Press the [Setup] button. Setup closes.

Notes:

- To store a name, you must select “OK” and press [Enter] in step 7, otherwise it will not be saved.
- You cannot enter a custom name for XM or SIRIUS radio presets.
- This procedure can also be performed on the AV receiver by using its [Setup], [Enter], and arrow buttons.

Satellite Radio

This item is for use with satellite radio. It’s not available if Satellite Radio is set to None (see page 109). See pages 65–73 for more information.

SIRIUS Parental Lock

This item is for use with SIRIUS Satellite Radio. It’s not available if Satellite Radio is set to None or XM (see page 109). See page 73 for more information.

Miscellaneous Setup

This section explains items on the Miscellaneous menu.

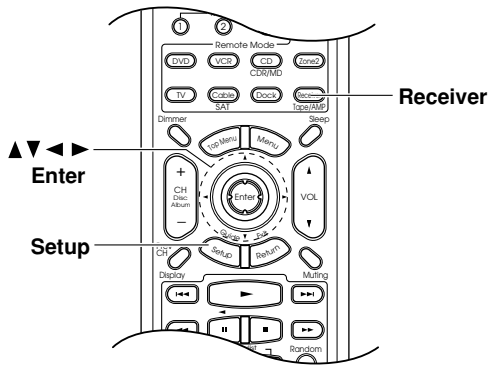

1 Press the [Receiver] Remote Mode button, followed by the [Setup] button. The main menu appears onscreen.

2 Use the Up and Down [▲]/[▼] buttons to select "6. Miscellaneous," and then press [Enter]. The Miscellaneous menu appears.

6. Miscellaneous			
1.	Volume Setup		
2.	OSD Setup		
3.	12V Trigger	A	Setup
4.	12V Trigger	B	Setup
5.	12V Trigger	C	Setup

3 Use the Up and Down [▲]/[▼] buttons to select an item, and then press [Enter]. The screen for that item appears.

4 Use the Up and Down [▲]/[▼] buttons to select an item, and use the Left and Right [◀]/[▶] buttons to change it. The items are explained below.

5 When you've finished, press the [Setup] button. Setup closes.

Note:

- This procedure can also be performed on the AV receiver by using its [Setup], [Enter], and arrow buttons.

Volume Setup

■ Volume Display

With this setting, you can choose how the volume level is displayed.

Absolute: Display range is Min, 0.5 through 99.5, Max.

Relative: Display range is $-\infty$ dB, -81.5 dB, -81.0 dB through $+18.0$ dB.

The absolute value 82 is equivalent to the relative value 0 dB.

■ Muting Level

This setting determines how much the output is muted when the Muting function is used (see page 79). It can be set to $-\infty$ dB (fully muted) or from -50 dB to -10 dB in 10 dB steps.

■ Maximum Volume

With this setting, you can limit the maximum volume.

When the Volume Display setting is set to Absolute, the Maximum Volume range is Off, 99 to 50. When it's set to Relative, the range is Off, $+17$ dB to -32 dB. To disable this setting, select Off.

■ Power On Volume

This setting determines what the volume will be each time the AV receiver is turned on.

When the Volume Display preference is set to Absolute, the range is Last, Min, 1 to Max. When it's set to Relative, the range is Last, $-\infty$ dB, -81 dB to $+18$ dB.

To use the same volume level as when the AV receiver was last turned off, select Last.

Note:

- The Power On Volume setting cannot be set higher than the Maximum Volume setting.

■ Headphone Level

With this setting, you can offset the headphone volume relative to the main volume. This is useful if your headphones are too loud or too quiet at the volume setting you usually use when listening through your speakers. The headphone level can be set from -12 dB to $+12$ dB.

■ Zone2 Maximum Volume

With this setting, you can limit the maximum volume for Zone 2.

When the Volume Display setting is set to Absolute, the Maximum Volume range is Off, 99 to 50. When it's set to Relative, the range is Off, $+17$ dB to -32 dB. To disable this setting, select Off.

■ Zone2 Power On Volume

This setting determines what the volume will be for Zone 2 each time the AV receiver is turned on.

When the Volume Display preference is set to Absolute, the range is Last, Min, 1 to Max. When it's set to Relative, the range is Last, $-\infty$ dB, -81 dB to $+18$ dB.

To use the same volume level as when the AV receiver was last turned off, select Last.

■ Zone3 Maximum Volume

With this setting, you can limit the maximum volume for Zone 3.

When the Volume Display setting is set to Absolute, the Maximum Volume range is Off, 99 to 50. When it's set to Relative, the range is Off, $+17$ dB to -32 dB. To disable this setting, select Off.

■ Zone3 Power On Volume

This setting determines what the volume will be for Zone 3 each time the AV receiver is turned on.

When the Volume Display preference is set to Absolute, the range is Last, Min, 1 to Max. When it's set to Relative, the range is Last, $-\infty$ dB, -81 dB to $+18$ dB.

To use the same volume level as when the AV receiver was last turned off, select Last.

OSD Setup

■ Immediate Display

This setting determines whether operation details are displayed onscreen immediately after an AV receiver function is used.

On: Displayed (default).

Off: Not displayed.

Even if On is selected, operation details are not output if the input source is connected to a COMPONENT VIDEO IN or HDMI IN.

For optimal video performance, THX recommends that Immediate Display be turned off.

■ Monitor Type

With this setting, you can specify the aspect ratio of your TV so that menus are displayed properly.

4:3: Select if your TV is 4:3 (default).

16:9: Select if your TV is 16:9.

■ Display Position

This setting determines where on the screen operation details are displayed.

Bottom: Bottom of the screen (default).

Top: Top of the screen.

■ TV Format

See "TV Format Setup (not North American models)" on page 58.

12V Trigger A/B/C Setup

See "Using the 12V Triggers" on page 117.

Hardware Setup

This section explains items on the Hardware menu.

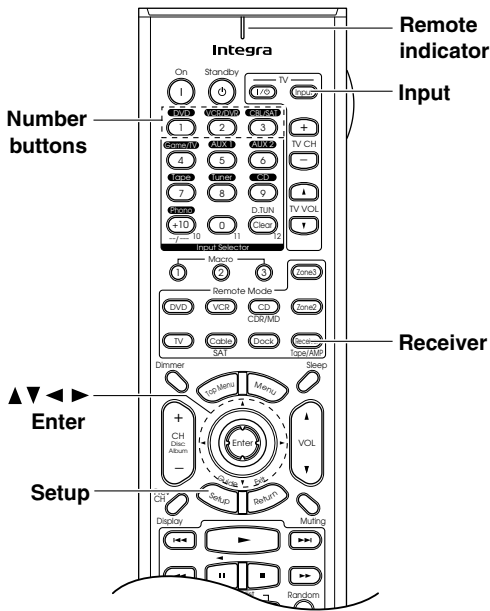

4



Use the Up and Down [**▲**]/[**▼**] buttons to select an item, and use the Left and Right [**◀**]/[**▶**] buttons to change it.

The items are explained below.

5



When you've finished, press the [Setup] button.

Setup closes.

Note:

- This procedure can also be performed on the AV receiver by using its [Setup], [Enter], and arrow buttons.

Remote Control

Remote ID

When several Integra/Onkyo components are used in the same room, their remote ID codes may overlap. To differentiate the AV receiver from the other components, you can change its remote ID from 1, the default, to 2 or 3.

Note:

- If you do change the AV receiver's remote ID, be sure to change the remote controller to the same ID (see below), otherwise, you won't be able to control it with the remote controller.

Changing the Remote Controller's ID

1

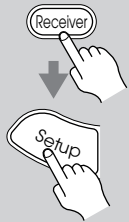

Press the [Receiver] Remote Mode button, followed by the [Setup] button.

The main menu appears onscreen.

2



Use the Up and Down [**▲**]/[**▼**] buttons to select "7. Hardware Setup," and then press [Enter].

The Hardware Setup menu appears.

7. Hardware Setup	
1. Remote Control	
2. Zone2/Zone3	
3. Tuner	
4. Analog Multich	
5. HDMI	

3



Use the Up and Down [**▲**]/[**▼**] buttons to select an item, and then press [Enter].

The screen for that item appears.

1

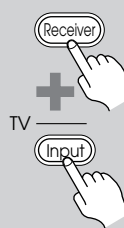

While holding down the [Receiver] Remote Mode button, press the TV [Input] button.

The Remote indicator flashes four times.

2

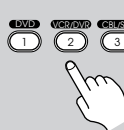

Use the number buttons to enter ID 1, 2, or 3.

The Remote indicator flashes twice.

Zone 2 and Zone 3

See "Zone 2 and Zone 3" on page 111.

Tuner

■ AM Freq Step (on some models)

See “AM Frequency Step Setup (on some models)” on page 59.

■ Satellite Radio (on North American model)

If you connect an XM Satellite Radio antenna or SIRIUS Satellite Radio antenna to the AV receiver (both sold separately), set this setting to XM or SIRIUS respectively. If you connect both types of antenna, select XM/SIRIUS. Otherwise, select None. See the separate Satellite Radio Guide for more information.

Analog Multich

■ Subwoofer Input Sensitivity

Some DVD players output the LFE channel from their analog subwoofer output at 15 dB higher than normal. With this setting, you can change the AV receiver’s subwoofer sensitivity to match your DVD player. Note that this setting only affects signals connected to the AV receiver’s MULTI CH SUBWOOFER jack.

You can select 0 dB, 5 dB, 10 dB, or 15 dB.

If you find that your subwoofer is too loud, try the 10 dB or 15 dB setting.

HDMI

■ HDMI Audio

This setting determines whether audio received by an HDMI input is output by the HDMI OUT. You may want to change this setting to On if your TV is connected to the HDMI OUT and you want to listen to audio from an HDMI component through your TV’s speakers. Normally, it should be set to Off.

Off: HDMI audio is not output (default).

On: HDMI audio is output.

Notes:

- If On is selected and the signal can be output by the TV, the AV receiver will output no sound through its speakers.
- When TV Control is enabled, this setting is set to Auto.
- With some TVs and input signals, no sound may be output even if On is selected.
- When the HDMI Audio setting is set to On, or TV Control is set to Enable and you’re listening through your TV’s speakers (see page 37), if you turn up the AV receiver’s volume control, the sound will be output by the AV receiver’s speakers. To stop the AV receiver’s speakers producing sound, change the settings, change your TV’s settings, or turn down the AV receiver’s volume.

■ Lip Sync

The Lip Sync function can automatically synchronize HDMI audio and video that’s gotten out of sync due to the complex digital video processing being performed by your HDMI-compatible TV. With HDMI Lip Sync, the audio delay required to synchronize the audio and video is calculated and applied automatically by the AV receiver.

Disable: HDMI lip sync disabled.

Enable: HDMI lip sync enabled.

Notes:

- This function works only if your HDMI-compatible TV supports HDMI Lip Sync.
- You can check the amount of delay being applied by the HDMI Lip Sync function on the A/V Sync screen (see page 104).

■ xvYCC

If your HDMI source and HDMI-compatible TV both support the xvYCC color standard, you can enable xvYCC color on the AV receiver with this setting.

Disable: xvYCC color disabled.

Enable: xvYCC color enabled.

■ Control

This function allows CEC-compatible components or RIHD-compatible components connected via HDMI to be controlled with the AV receiver.

Disable: HDMI Control disabled.

Enable: HDMI Control enabled.

Notes:

- Select Disable if a connected component is incompatible or you’re not sure about its compatibility.
- If operation is unreliable when set to Enable, select Disable instead.
- When the HDMI Audio setting is set to On, or TV Control is set to Enable and you’re listening through your TV’s speakers (see page 37), if you turn up the AV receiver’s volume control, the sound will be output by the AV receiver’s speakers. To stop the AV receiver’s speakers producing sound, change the settings, change your TV’s settings, or turn down the AV receiver’s volume.

Power Control

To link the power functions of CEC-compatible components or RIHD-compatible components connected via HDMI, select Enable.

Disable: Power Control disabled.

Enable: Power Control enabled.

Notes:

- The Power Control setting can be set only when the above Control setting is set to Enable.

Advanced Setup—Continued

- HDMI power control only works with HDMI-compatible components that support it and may not work properly with some components due to their settings or compatibility.
- When set to Enable, the AV receiver consumes more power.
- When set to Enable, the AV receiver enters Ready mode when set to Standby, and the READY indicator lights up instead of the STANDBY indicator (not North American model). Also, the AV receiver's AC outlets will be on all of the time regardless of whether the AV receiver is set to On or Standby, or Ready mode in this case.

TV Control

Select Enable to control the AV receiver from an RIHD-compatible TV connected via HDMI.

Disable: TV Control disabled.

Enable: TV Control enabled.

Notes:

- Select Disable if your TV is incompatible or you're not sure about its compatibility.
- The TV Control setting can be set only when the above Control and Power Control settings are both set to Enable.

Note:

- After changing the Control, Power Control, or TV Control setting, be sure to turn all of your components off and then back on again. Refer to the instruction manuals for your other components.

Network

These settings are for use with home automation equipment and external controllers.

Lock Setup

Lock

With this setting, you can protect your settings by locking the setup menus.

Locked: Setup menus locked.

Unlocked: Setup menus unlocked.

When Locked is selected, only this Lock Setup item can be accessed.

Zone 2 and Zone 3

In addition to your main listening room, you can also enjoy playback in two other rooms, or as we call them, Zone 2 and Zone 3. And, you can select a different source for each room.

Connecting Zone 2

There are two ways you can connect Zone 2 speakers:

1. Connect them directly to the AV receiver.
2. Connect them to an amp in Zone 2.

Connecting Your Zone 2 Speakers Directly to the AV receiver

This setup allows 5.1-channel playback in your main room and 2-channel stereo playback in Zone 2, with a different source in each room. This is called Powered Zone 2, as the Zone 2 speakers are powered by the AV receiver. Note that when Powered Zone 2 is turned off, you can enjoy 7.1-channel playback in your main room.

Hookup

- Connect your Zone 2 speakers to the AV receiver's ZONE 2 L/R speaker terminals.

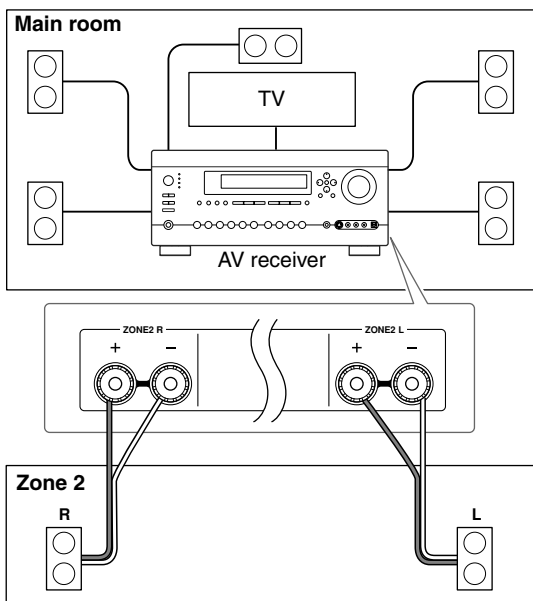

You must set the Powered Zone 2 setting to Act (Activated) to use this setup (see page 113).

Note:

- With this setup, the Zone 2 volume is controlled by the AV receiver.

Connecting Your Zone 2 Speakers to an Amp in Zone 2

This setup allows 7.1-channel playback in your main listening room and 2-channel stereo playback in Zone 2, with a different source in each room.

Hookup

- Use an RCA audio cable to connect the AV receiver's ZONE 2 PRE OUT L/R jacks to an analog audio input on your Zone 2 amp.
- Use an RCA audio cable to connect the AV receiver's ZONE 2 PRE OUT SW jack to the line input on a powered subwoofer in Zone 2.
- Connect your Zone 2 speakers to the speaker terminals on your Zone 2 amp.

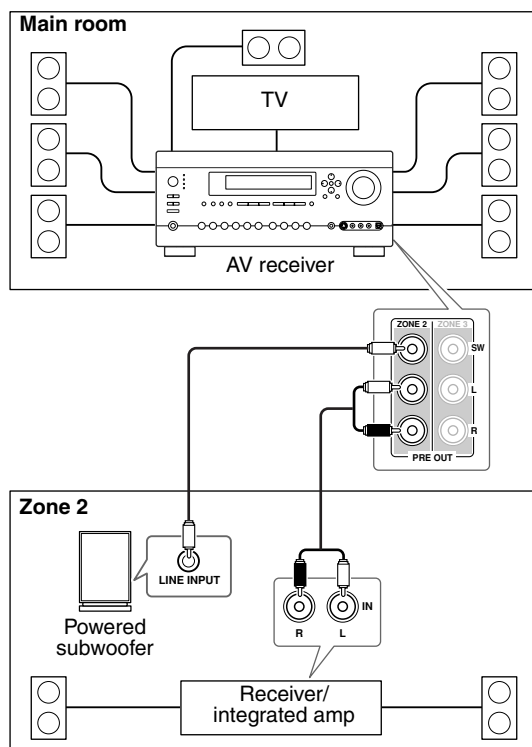

Note:

- With the default settings, the Zone 2 volume must be set on the Zone 2 amp. If your Zone 2 amp has no volume control, set the Zone 2 Out setting to Variable so that you can set the Zone 2 volume on the AV receiver (see page 114).

Zone 2 Video Outputs

The AV receiver features a composite video output and component video output for connection to a TV in Zone 2, so you can enjoy both audio and video in that zone.

Hookup

- Use a composite video cable to connect the AV receiver's ZONE 2 OUT V jack to a composite video input on your Zone 2 TV.
- Alternatively, use a component video cable to connect the AV receiver's COMPONENT VIDEO MONITOR OUT 2/ZONE 2 OUT jacks to a component video input on your Zone 2 TV.

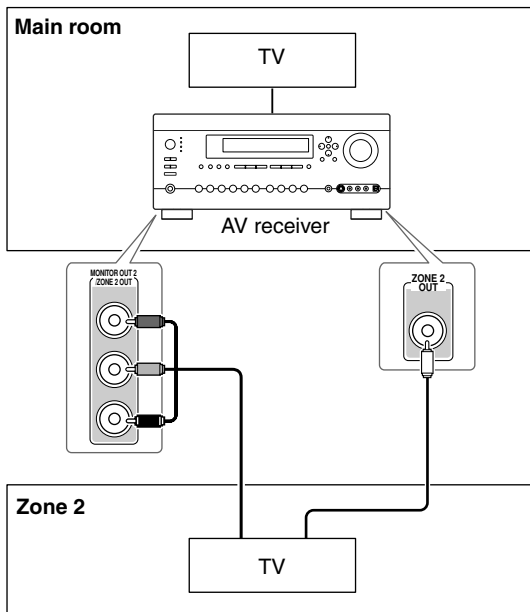

- If you use the COMPONENT VIDEO MONITOR OUT 2/ZONE 2 OUT, you must set the Monitor Out2 setting to Zone 2 (see page 45).

Notes:

- The ZONE 2 OUT V jack outputs video from components connected to composite video inputs and S-Video inputs.
- The COMPONENT VIDEO MONITOR OUT 2/ZONE 2 OUT outputs video from components connected to component video inputs.

Connecting Zone 3

Zone 3 speakers must be connected to an amp in Zone 3.

Connecting Your Zone 3 Speakers

You can enjoy 2-channel stereo playback in Zone 3 and a different source to those selected for your main room and Zone 2.

Hookup

- Use an RCA audio cable to connect the AV receiver's ZONE 3 PRE OUT L/R jacks to an analog audio input on your Zone 3 amp.
- Use an RCA audio cable to connect the AV receiver's ZONE 3 PRE OUT SW jack to the line input on a powered subwoofer in Zone 3.
- Connect your Zone 3 speakers to the speaker terminals on your Zone 3 amp.

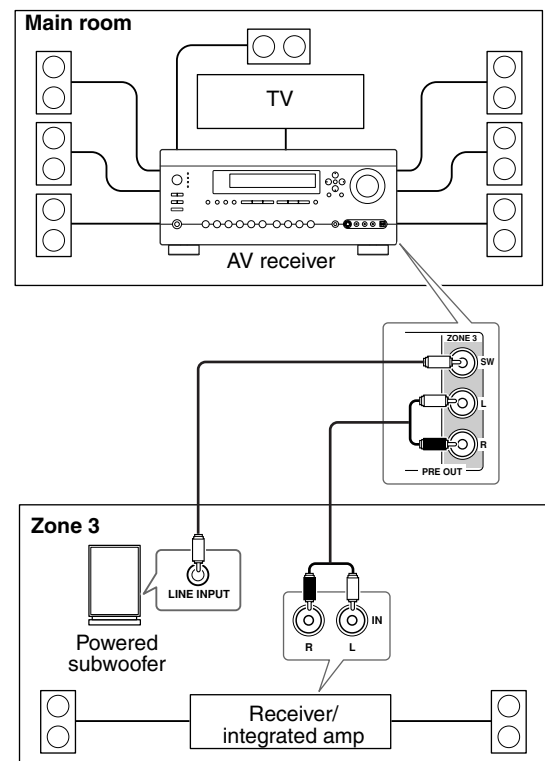

Note:

- With the default settings, the Zone 3 volume must be set on the Zone 3 amp. If your Zone 3 amp has no volume control, set the Zone 3 Out setting to Variable so that you can set the Zone 3 volume on the AV receiver (see page 114).

Powered Zone 2 Setting

If you've connected your Zone 2 speakers to the AV receiver, as explained in "Connecting Your Zone 2 Speakers Directly to the AV receiver" on page 111, you must set the Powered Zone 2 setting to Act (Activated).

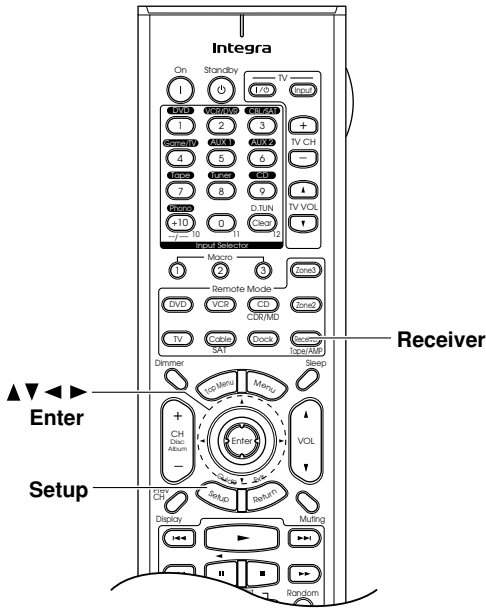

1

Press the [Receiver] Remote Mode button, followed by the [Setup] button.

The main menu appears onscreen.



2

Use the Up and Down [▲]/[▼] buttons to select "7. Hardware Setup," and then press [Enter].

The Hardware Setup menu appears.

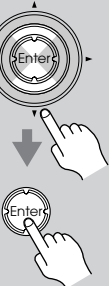

3

Use the Up and Down [▲]/[▼] buttons to select "2. Zone 2/Zone 3," and then press [Enter].

The Zone 2/Zone 3 screen appears.



7-2. Zone2/Zone3	
Powered Zone2	◀ Not Act ▶
Zone2 Out	Fixed
Zone3 Out	Fixed

4

Use the Up and Down [▲]/[▼] buttons to select "Powered Zone 2," and use the Left and Right [◀]/[▶] buttons to select:

Not Act: ZONE 2 L/R speaker terminals not activated (Powered Zone 2 disabled).

Act: ZONE 2 L/R speaker terminals activated (Powered Zone 2 enabled).



5

Press the [Setup] button.

Setup closes.



Notes:

- When Act is selected and Zone 2 turned on, the Zone 2 speakers connected to the ZONE 2 L/R speaker terminals output sound, but the surround back speakers connected to the SURR BACK L/R speaker terminals do not. When Act is selected and Zone 2 turned off, the surround back speakers output sound as normal.
- This procedure can also be performed on the AV receiver by using its [Setup], [Enter], and arrow buttons.

Zone 2/Zone 3 Out Settings

If you've connected your Zone 2 or Zone 3 speakers to an amp with no volume control, set the Zone 2 Out or Zone 3 Out setting, respectively, to Variable so that you can set the zone's volume, balance, and tone on the AV receiver.

1 Press the [Receiver] Remote Mode button, followed by the [Setup] button.
The main menu appears onscreen.

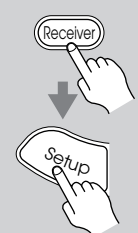

2 Use the Up and Down [▲]/[▼] buttons to select "7. Hardware Setup," and then press [Enter].
The Hardware Setup menu appears.

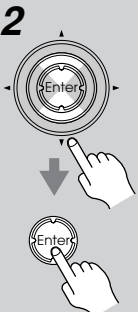

3 Use the Up and Down [▲]/[▼] buttons to select "2. Zone 2/Zone 3," and then press [Enter].
The Zone 2/Zone 3 screen appears.

7-2. Zone2/Zone3	
Powered Zone2	◀ Not Act ▶
Zone2 Out	Fixed
Zone3 Out	Fixed

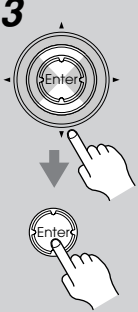

4 Use the Up and Down [▲]/[▼] buttons to select "Zone 2 Out" or "Zone 3 Out," and use the Left and Right [◀]/[▶] buttons to select:

Fixed: The Zone 2 or Zone 3 volume must be set on the amp in that zone.

Variable: The Zone 2 or Zone 3 volume can be set on the AV receiver.

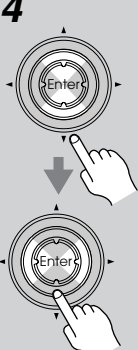

5

Press the [Setup] button.
Setup closes.



Note:

- This procedure can also be performed on the AV receiver by using its [Setup], [Enter], and arrow buttons.

Using Zone 2 and Zone 3

This section explains how to use Zone 2 and Zone 3.

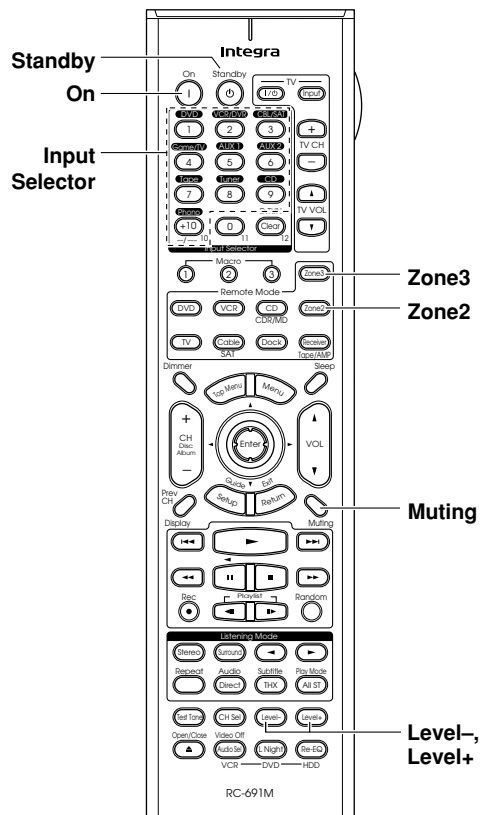
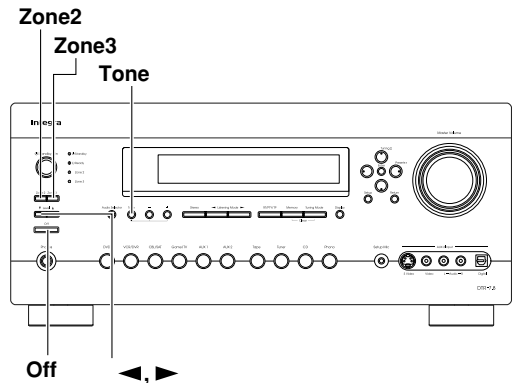

Selecting an Input Source for Zones

1

Remote controller

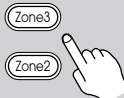

AV receiver

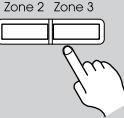

On the remote controller, press the [Zone 2] or [Zone 3] Remote Mode button.

On the AV receiver, press the [Zone 2] or [Zone 3] button.

The Zone 2 or Zone 3 indicator flashes, and the input selector currently selected for the zone appears on the display.

2

Remote controller



AV receiver

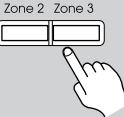

On the remote controller, use the Input Selector buttons.

On the AV receiver, use the input selector buttons, or press the [Zone 2] or [Zone 3] button repeatedly

The input source is selected, the zone is turned on, the name of the input selector appears on the display, and the Zone 2 or Zone 3 indicator lights continuously.

Notes:

- To select AM or FM, press the [Tuner] input selector button repeatedly. On the North American model, you can also select XM or SIRIUS.
- Only analog input sources are output by Zone 2 and Zone 3. Digital input sources are not output. If no sound is heard when an input source is selected, check to make sure it's connected to an analog input.
- While Powered Zone 2 is being used, listening modes that require surround back speakers (6.1/7.1), such as Dolby Digital EX, DTS-ES, and THX Ultra2 Cinema, are unavailable.
- While Zone 2 or Zone 3 is on, the Auto Power On/Standby and Direct Change **RI** functions do not work.
- You cannot select different AM or FM radio stations for your main room, Zone 2, and Zone 3. The same AM/FM radio station will be heard in each room.

- On the North American model, you can select a different radio source for each room. For example, XM for your main room, SIRIUS for Zone 2, and AM/FM for Zone 3.

Turning Off Zones

1

Remote controller

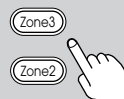

AV receiver



On the remote controller, press the [Zone 2] or [Zone 3] Remote Mode button.

On the AV receiver, press the [Zone 2] or [Zone 3] button.

The Zone 2 or Zone 3 indicator flashes.

2

Remote controller



AV receiver

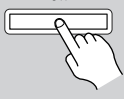

On the remote controller, press the [Standby] button.



On the AV receiver, press the [Off] button.

The zone is turned off, and the Zone 2 or Zone 3 indicator goes off.

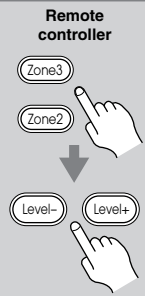
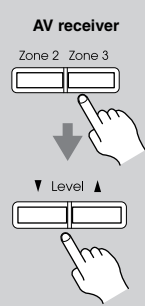
Adjusting the Volume of Zones

 <p>Remote controller</p>	<p>On the remote controller, press the [Zone 2] or [Zone 3] Remote Mode button, and then use the [Level-] and [Level+] buttons.</p>
 <p>AV receiver</p>	<p>On the AV receiver, press the [Zone 2] or [Zone 3] button, and then use the Level Up and Down [▲]/[▼] buttons.</p>

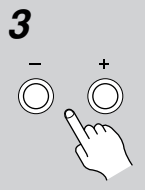

Adjusting the Balance of Zones

<p>1</p>  <p>AV receiver</p>	<p>On the AV receiver, press the [Zone 2] or [Zone 3] button.</p>
<p>2</p>  <p>Tone</p>	<p>Press the AV receiver's [Tone] button repeatedly to select Balance.</p>
<p>3</p> 	<p>Use the Tone Plus [+] and Minus [-] buttons to adjust the balance. You can adjust the balance from 0 in the center to +10 dB to the right or -10 dB to the left in 2 dB steps.</p>

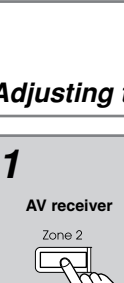
Muting Zones

	<p>On the remote controller, press the [Zone 2] or [Zone 3] Remote Mode button, and then press the [Muting] button.</p>
	<p>To unmute a zone, on the remote controller, press the [Zone 2] or [Zone 3] Remote Mode button, and then press the [Muting] button again.</p>

Adjusting the Tone of Zone 2

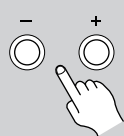
<p>1</p>  <p>AV receiver</p>	<p>On the AV receiver, press the [Zone 2] button.</p>
<p>2</p>  <p>Tone</p>	<p>Press the AV receiver's [Tone] button repeatedly to select Bass or Treble.</p>
<p>3</p> 	<p>Use the Tone Plus [+] and Minus [-] buttons to adjust the bass or treble. You can boost or cut the Bass or Treble from -10 dB to +10 dB in 1 dB steps.</p>

Notes:

- Zones can also be unmuted by adjusting the volume.
- The tone cannot be adjusted for Zone 3.
- The Zone 2 level, balance, and tone functions have no effect on the ZONE 2 PRE OUT when the Zone 2 Out setting is set to Fixed (page 114).
- The Zone 3 level and balance functions have no effect on the ZONE 3 PRE OUT when the Zone 3 Out setting is set to Fixed (page 114).

Using the 12V Triggers

The 12V triggers A, B, and C can be used to turn on 12V trigger-capable components automatically when they are selected as the input source. The triggers can be set so that they activate when a connected component is selected as the input source for the main room, Zone 2, Zone 3, or any combination of rooms.

When triggered, the output from a 12V TRIGGER OUT goes high (+12 volts, 100 milliamperes max).

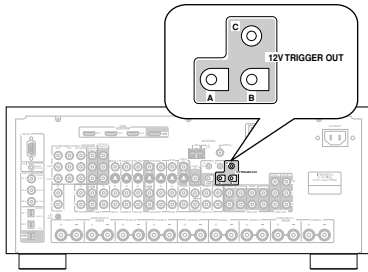

Hookup

- Use a miniplug cable to connect the AV receiver's 12V TRIGGER OUT A, B, or C jack to the 12 V trigger input on a connected component.

When several components are turned on simultaneously by using triggers A, B, and C, depending on the type of components, a large amount of current may be drawn momentarily. To prevent this, you can delay trigger signals A, B, and C individually. Another application for trigger delay is eliminating the “thump” noise that’s sometimes heard when a source component is turned on. Delaying the trigger signal for your power amplifier so that it’s the last component to be turned on will accomplish this.

1 Press the [Receiver] Remote Mode button, followed by the [Setup] button.



The main menu appears onscreen.

2 Use the Up and Down [▲]/[▼] buttons to select “6. Miscellaneous,” and then press [Enter].

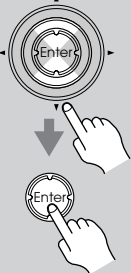

The Miscellaneous menu appears.

6. Miscellaneous		
1. Volume Setup		
2. OSD Setup		
3. 12V Trigger A	Setup	
4. 12V Trigger B	Setup	
5. 12V Trigger C	Setup	

3 Use the Up and Down [▲]/[▼] buttons to select “12V Trigger A, B, or C,” and then press [Enter].



The 12V Trigger A/B/C Setup screen appears.

6-x.12V Trigger x Setup		
Delay	◀	1sec ▶
DVD		Main/Zone2
VCR/DVR		Main/Zone2
CBL/SAT		Main/Zone2
TV/GAME		Main/Zone2
AUX1		Main/Zone2
AUX2		Main/Zone2
TAPE		Main/Zone2
TUNER		Main/Zone2
CD		Main/Zone2
PHONO		Main/Zone2

4 Use the Up and Down [▲]/[▼] buttons to select “Delay,” and use the Left and Right [◀]/[▶] buttons to select: 0 sec, 1 sec, 2 sec, or 3 sec.

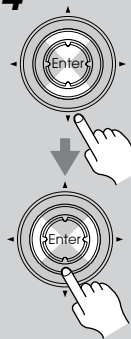

When 0 sec is selected, the trigger signal is output as soon as the input source is changed.

5 Use the Up and Down [▲]/[▼] buttons to select an input source, and use the Left and Right [◀]/[▶] buttons to select an option.

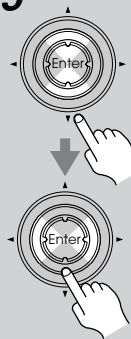

Off: No trigger signal is output. A 12-volt trigger signal is output when the connected component is selected as the source for:

- Main:** Main room.
- Zone2:** Zone 2.
- Main/Z2:** Main room or Zone 2.
- Zone3:** Zone 3.
- Main/Z3:** Main room or Zone 3.
- Z2/Z3:** Zone 2 or Zone 3.
- Main/Z2/Z3:** Main room, Zone 2, or Zone 3.

6 When you’ve finished, press the [Setup] button.



Setup closes.

Using the Remote Controller in Zone 2/3 and Multiroom Control Kits

To control the AV receiver with the remote controller while you're in Zone 2 or Zone 3, you'll need a commercially available multiroom remote control kit for each zone.

- Multiroom kits are made by Niles and Xantech. These kits can also be used when there isn't a clear line of sight to the AV receiver's remote sensor, such as when it's installed inside a cabinet.

Using a Multiroom Kit with Zone 2/3

In this setup, the IR receiver in Zone 2/3 picks up the infrared signals from the remote controller and feeds them through to the AV receiver in the main room via the connecting block.

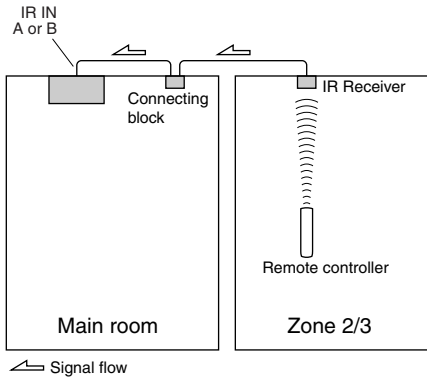

The miniplug cable from the connecting block should be connected to the AV receiver's IR IN A or B jack, as shown below. The IR IN A and B jacks are identical. Up to two IR receivers can be connected.

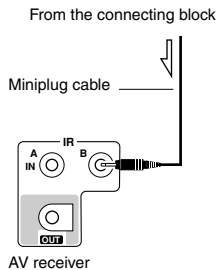

Using a Multiroom Kit with a Cabinet

In this setup, the IR receiver picks up the infrared signals from the remote controller and feeds them to the AV receiver located in the cabinet via the connecting block.

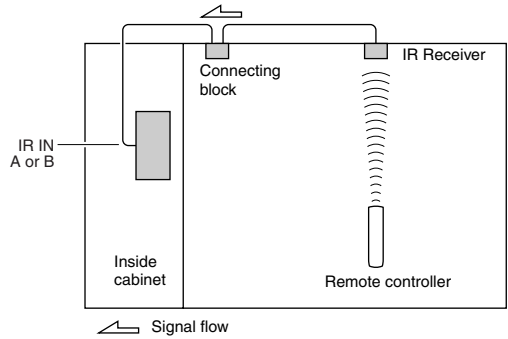

Using a Multiroom Kit with Other Components

In this setup, an IR emitter is connected to the AV receiver's IR OUT jack and placed in front of the other component's remote control sensor. Infrared signals received at the AV receiver's IR IN A or B jack are fed through to the other component via the IR emitter. Signals picked up by the AV receiver's remote control sensor are not output.

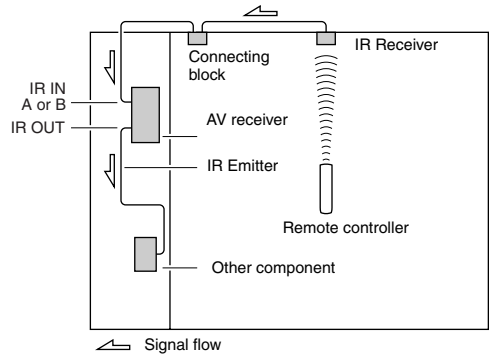

The IR emitter should be connected to the AV receiver's IR OUT jack, as shown below.

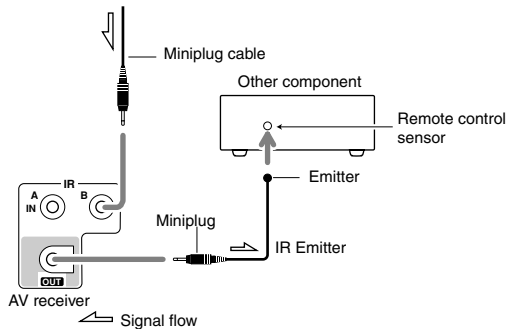

Controlling Other Components

You can control your other components, including those made by other manufacturers, with the remote controller. This section explains how to:

- Enter the remote control code for a component that you want to control: DVD, TV, VCR, etc.
- Learn commands directly from another component's remote controller (see page 122).
- Program the Macro buttons to perform a sequence of up to eight remote control actions (see page 123).

Entering Remote Control Codes

To control another component, you must first enter that component's remote control code to a Remote Mode button. You'll need to enter a code for each component that you want to control.

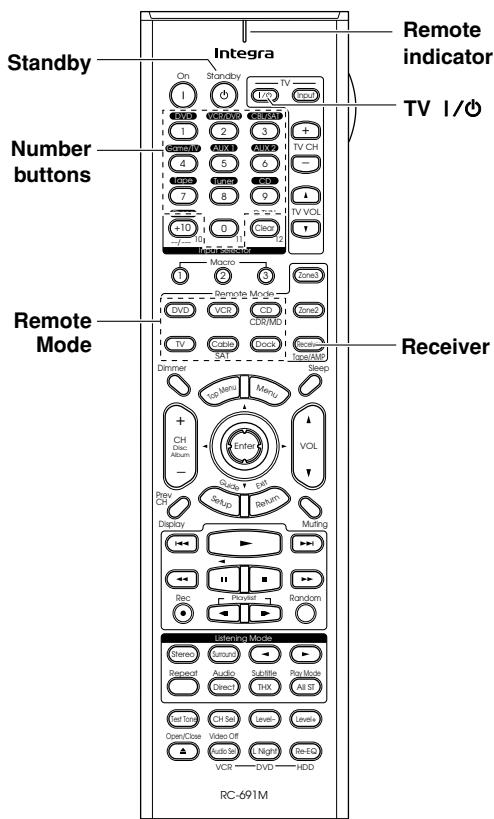

1 Look up the component's remote control code in the separate Remote Control Codes list. The codes are organized by category.

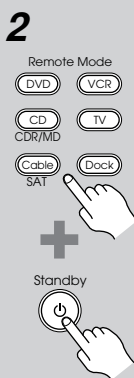

2 While holding down the Remote Mode button to which you want to enter the code, press the [Standby] button.

The Remote indicator lights up.



3 Within 30 seconds, use the number buttons to enter the 4-digit remote control code.

The Remote indicator flashes twice.

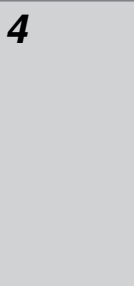

4 Press the Remote Mode button again to select the remote controller mode, point the remote controller at the component, and check the operation.

If the remote controller doesn't work as expected, and several remote codes are listed, try each one in turn and use the one that works best.

Notes:

- Remote control codes cannot be entered for the [Receiver] Remote Mode buttons.
- The remote control codes provided are correct at the time of printing but subject to change.

- The Dock remote mode can only be used with the Onkyo RI Dock at this time.
- The [DVD] and [CD] Remote Mode buttons are preprogrammed for use with Integra/Onkyo DVD players and CD players, respectively.
- To control another manufacturer's CD recorder or MD recorder, enter the appropriate remote control code to the [CD] Remote Mode button.

Remote Control Codes for Integra/Onkyo Components Connected via RI

Integra/Onkyo components that are connected via **RI** are controlled by pointing the remote controller at the AV receiver, not the component. This allows you to control components that are out of view, in a rack, for example.

1 Make sure the Integra/Onkyo component is connected with an **RI** cable and an analog audio cable (RCA).

See page 42 for details.

2 Enter the appropriate remote control code to the Remote Mode button.

- [DVD] Remote Mode button
5002: Integra/Onkyo DVD player with **RI**
- [CD] Remote Mode button
6002: Integra/Onkyo CD player with **RI**
- [MD] Remote Mode button
6008: Onkyo MD recorder with **RI**
- [CDR] Remote Mode button
6006: Onkyo CD recorder with **RI**
- [DOCK] REMOTE MODE button
6004: Onkyo RI Dock DS-A1 with **RI**

See the previous page for how to enter remote control codes.

3 Press the Remote Mode button, point the remote controller at the AV receiver, and operate the component.

If you want to control an Integra/Onkyo component by pointing the remote controller directly at it, or you want to control an Integra/Onkyo component that's not connected via **RI**, use the following remote control codes:

- [DVD] Remote Mode button
5001: Integra/Onkyo DVD player without **RI** (default)
- [CD] Remote Mode button
6001: Integra/Onkyo CD player without **RI** (default)
- [MD] Remote Mode button
6007: Onkyo MD recorder without **RI**
- [CDR] Remote Mode button
6005: Onkyo CD recorder without **RI**
- [DOCK] REMOTE MODE button
6003: Onkyo RI Dock DS-A2 without **RI** (default)

Note:

- If you connect an **RI**-capable Onkyo MiniDisc or CD recorder to the TAPE IN/OUT jacks, for remote operation to work properly, you must set the Input Display to MD or CDR, respectively (see page 49).

Resetting the Remote Mode Buttons

You can reset a Remote Mode button to its default remote control code.

1

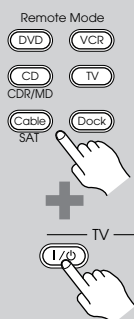

While holding down the Remote Mode button that you want to reset, press the TV [I/⏻] button.

The Remote indicator flashes three times.

2



Press the Remote Mode button again.

The Remote indicator flashes twice, indicating that the button has been reset.

The [DVD] and [CD] Remote Mode buttons are preprogrammed with remote control codes for controlling Integra/Onkyo DVD players and CD players, respectively. When these buttons are reset, the preprogrammed codes are restored.

Resetting the Remote Controller

You can reset the remote controller to its default settings.

1



While holding down the [Receiver] Remote Mode button, press the [Standby] button.

The Remote indicator flashes five times.

2



Press the [Receiver] Remote Mode button again.

The Remote indicator flashes twice, indicating that the remote controller has been reset.

Controlling Other Components—Continued

To control another component, point the remote controller at it and use the buttons explained below. (You must select the appropriate remote controller mode with the Remote Mode buttons first.) With some components, certain buttons may not work as expected, and some may not work at all.

■ Controlling a TV

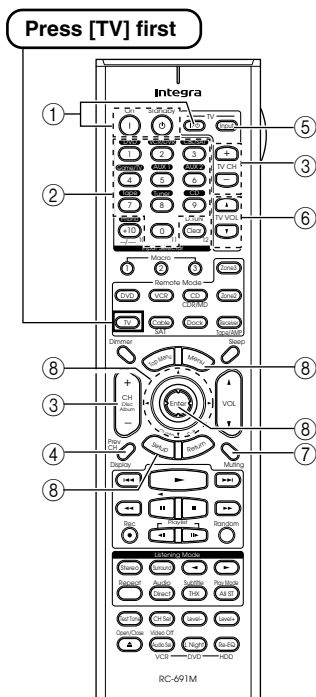

- ① **[On], [Standby], TV [⏻/⏿]***
Set the TV to On or Standby.
- ② **Number buttons**
Enter numbers.
- ③ **[CH +/-], TV CH [+]/[-]***
Select channels on the TV.
- ④ **[Prev CH]**
Selects the previous channel.
- ⑤ **[TV Input]***
Selects the TV's external inputs.
- ⑥ **TV VOL [▲]/[▼]***
Adjust the TV's volume.
- ⑦ **[Muting]**
Mutes the TV.
- ⑧ **[▲]/[▼]/[◀]/[▶]/[Menu]/[Enter]/[Return]**
Navigate menus on the TV.

Buttons marked with an asterisk () are exclusively for controlling a TV and can be used at any time, regardless of the currently selected remote controller mode.

■ Controlling a VCR

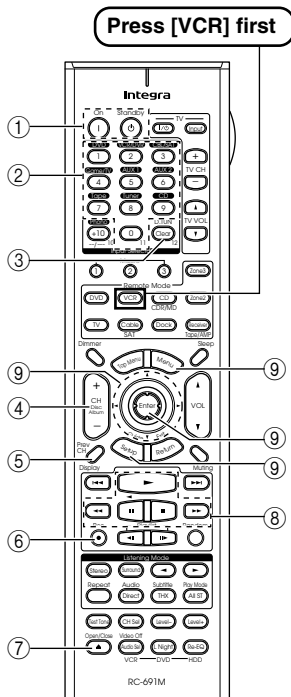

- ① **[On], [Standby]**
Set the VCR to On or Standby.
- ② **Number buttons**
Enter numbers.
- ③ **[Clear]**
Cancels functions.
- ④ **[CH +/-]**
Selects channels on the VCR.
- ⑤ **[Prev CH]**
Selects the previous channel.
- ⑥ **Rec [●]**
Starts recording.
- ⑦ **Eject [▲]**
Ejects the videocassette.
- ⑧ **[▶], [⏸], [■], [◀], [▶▶]**
Play, Pause, Stop, Rewind, and Fast forward.
- ⑨ **[▲]/[▼]/[◀]/[▶]/[Menu]/[Enter]/[Return]**
Navigate menus on the VCR.

■ Controlling a Satellite or Cable Receiver

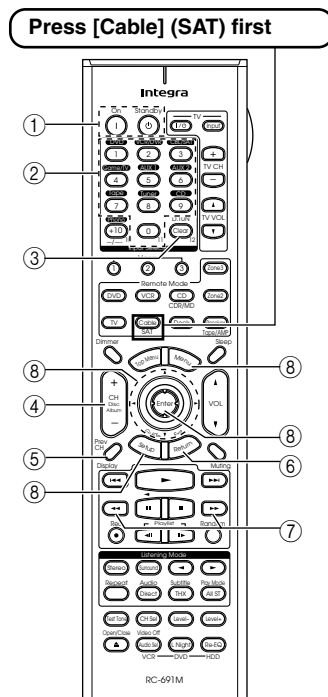



- ① **[On], [Standby]**
Set the satellite/cable receiver to On or Standby.
- ② **Number buttons**
Enter numbers.
- ③ **[Clear]**
Cancels functions.
- ④ **[CH +/-]**
Selects satellite/cable channels.
- ⑤ **[Prev CH]**
Selects the previous channel.
- ⑥ **[Guide]**
Displays the program guide.
- ⑦ **[◀◀], [▶▶]**
Rewind and Fast forward.
- ⑧ **[▲]/[▼]/[◀]/[▶]/[Menu]/[Enter]/[Return]**
Navigate menus on the satellite/cable receiver.

Learning Commands

The AV receiver's remote controller can learn the commands of other remote controllers. By transmitting, for example, the Play command from your CD player's remote controller, the remote controller can learn it, and then transmit the exact same command when its Play [▶] button is pressed in the CD remote mode.

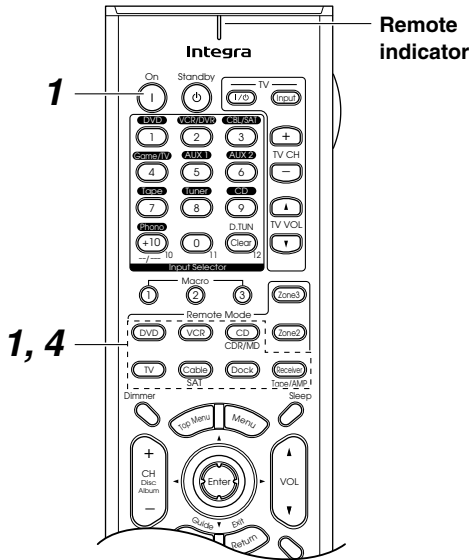
This is useful when you've entered the appropriate remote control code (page 119) but some buttons don't work as expected.



<p>1</p> <p>Remote Mode</p> <p>DVD VCR</p> <p>CD TV</p> <p>CDR/MD</p> <p>Cable Dock</p> <p>SAT</p> <p>Receive Tape/AMP</p> <p>+</p> <p>On</p> 	<p>While holding down the Remote Mode button for the mode in which you want to use the command, press the [On] button.</p> <p>The Remote indicator lights up.</p>
<p>2</p>	<p>Press the button you want to learn the new command.</p>
<p>3</p>	<p>Point the remote controllers at each other, about 2 to 6 inches (5–15 cm) apart, and then press and hold the button whose command you want to learn until the Remote indicator flashes.</p>

If the command is learned successfully, the Remote indicator flashes twice.

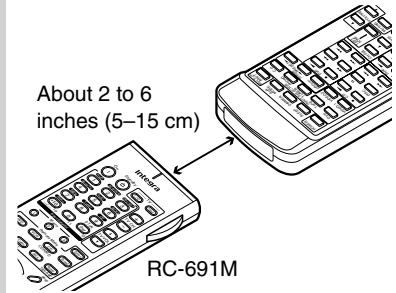

4 To learn more commands, repeat steps 2 and 3. Press any Remote Mode button when you've finished.

Notes:

- The following buttons cannot learn new commands: Remote Mode, Macro [1], [2], [3], TV CH [+]/[-], Re-EQ, Light.
- When you want to learn the command from your TV's Power button, select the TV remote control mode and use the remote controller's [Standby] button to learn the command. In the TV remote control mode, the remote controller's [Standby] and TV [I/⏻] buttons are linked, so using the [Standby] button to learn the command will mean that you can also use the TV [I/⏻] button to turn your TV on or off in TV remote control mode.
- When you want to learn the commands from your TV's Channel Up and Down buttons, select the TV remote control mode and use the remote controller's CH [+/-] button (left to the [Enter] button) to learn the commands. In the TV remote control mode, the remote controller's CH [+/-] and TV CH [+]/[-] buttons are linked, so using the CH [+/-] button to learn these commands will mean that you can also use the TV CH [+]/[-] buttons to change channels in TV remote control mode.
- The remote controller can learn approximately 70 to 90 commands, although this will be less if commands that use a lot of memory are learned.
- Remote controller buttons such as Play, Stop, Pause, and so on are preprogrammed with commands for controlling Onkyo CD players, cassette decks, and DVD players. However, they can learn new commands, and you can restore the preprogrammed commands at any time by resetting the remote controller (see page 120).
- To overwrite a previously learned command, repeat this procedure.
- Only commands from infrared remote controllers can be learned.
- When the remote controller's batteries expire, all learned commands will be lost and will have to be learned all over again, so don't discard your other remote controllers.

Using Macros

You can program the remote controller's Macro buttons to perform a sequence of remote control actions.

Example:

To play a CD you typically need to perform the following actions:

1. Press the [Receiver] Remote Mode button to select the Receiver remote controller mode.
2. Press the [On] button to turn on the AV receiver.
3. Press the [CD] Input Selector button to select the CD input source.
4. Press the [CD] Remote Mode button to select the CD remote controller mode.
5. Press the Play [▶] button to start playback on the CD player.

You can program a Macro button so that all five actions are performed with just one button press.

Making Macros

Each Macro button can store one macro, and each macro can contain up to eight commands.

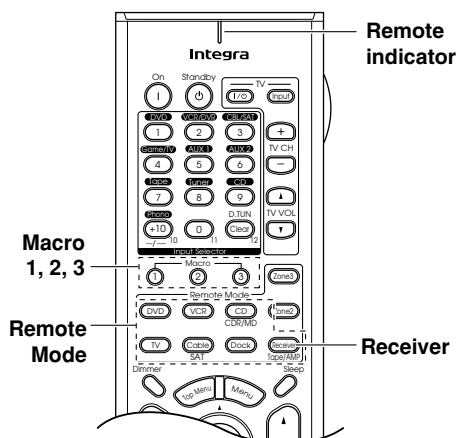

1

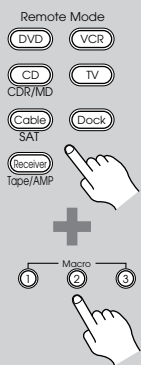

While holding down the Remote Mode button of the remote controller mode you want to use at the start of the macro, press Macro button [1], [2], or [3].

The Remote indicator lights up.

For the CD example in the left column, you'd press and hold the [Receiver] Remote Mode button, and then press Macro button [1], [2], or [3].

2

Press the buttons whose actions you want to program into the macro in the order you want them performed.

For the CD example in the left column, you'd press the following buttons: [ON], [CD] Input Selector, [CD] Remote Mode, Play [▶].

3

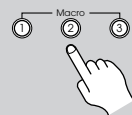

When you've finished, press the Macro button again.

The Remote indicator flashes twice. If you enter eight commands, the process will finish automatically.

Note:

- If any of the buttons you used to make a macro are taught new commands, the macro will no longer work properly and will have to be made again.

Running Macros



Press the Macro [1], [2], or [3] button.

The commands in the macro are transmitted in the order in which they were programmed. Keep the remote controller pointed at the AV receiver until all of the commands have been transmitted.

Macros can be run at any time, regardless of the current remote controller mode.

Deleting Macros

1

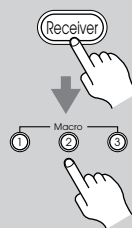

While holding down the [Receiver] Remote Mode button, press the Macro button whose macro you want to delete.

2

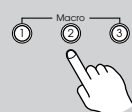

Press the Macro button again.

Troubleshooting

If you have any trouble using the AV receiver, look for a solution in this section. If you can't resolve the issue yourself, contact the dealer from whom you purchased this unit.

If you can't resolve the issue yourself, try resetting the AV receiver before contacting the dealer from whom you purchased this unit.

To reset the AV receiver to its factory defaults, turn it on and, while holding down the [VCR/DVR] button, press the [Standby/On] button. "Clear" will appear on the display and the AV receiver will enter Standby mode.

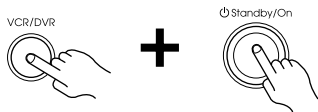

Note that resetting the AV receiver will delete your radio presets and custom settings.

Power

Can't turn on the AV receiver

- Make sure that the power cord is plugged into the wall outlet properly.
- Unplug the power cord from the wall outlet, wait 5 seconds or more, then plug it back in again.

The AV receiver turns off as soon as it's turned on

- The amp protection circuit has been activated. Remove the power cord from the wall outlet immediately. Disconnect all speaker cables and input sources, and leave the AV receiver with its power cord disconnected for 1 hour. After that, reconnect the power cord and set the volume to maximum. If the AV receiver stays on, set the volume to minimum, disconnect the power cord, and reconnect your speakers and input sources. If the AV receiver turns off when you set the volume to maximum, disconnect the power cord, and contact the dealer from whom you purchased this unit.

Audio

There's no sound or it's very quiet

- Make sure that the digital input is assigned to the input selector (page 50).
- Make sure that the correct audio input is selected (page 81).
- Make sure that all audio connecting plugs are pushed in all the way (page 26).
- Make sure that the polarity of the speaker cables is correct, and that the bare wire is in contact with the metal part of each speaker terminal (page 22).
- Make sure that the speaker cables are not shorting.
- Check the volume (page 60). The AV receiver is designed for home theater enjoyment and has a wide volume range for precise adjustment.

- If the MUTING indicator is flashing on the display, press the remote controller's [Muting] button to unmute the AV receiver (page 79).
- While a pair of headphones is connected to the Phones jack, no sound is output by the main room speakers (page 80).
- Check the digital audio output settings on the source component. On some game consoles, such as those that can play DVDs, the default setting is off.
- With some DVD-Video discs, you need to select an audio format from a menu or with the AUDIO button on your DVD player's remote controller.
- If your turntable uses an MC cartridge, you must use an MC head amp or MC transformer (page 39).
- Check the speaker settings (pages 96–101).
- If the digital signal format is set to PCM or DTS, set it to Auto (page 81).
- If there's no sound from a DVD player connected to an HDMI IN, check the DVD player's output settings, and be sure to select a compatible audio format.

Only the front speakers produce sound

- When the Stereo listening mode is selected, only the front speakers and subwoofer produce sound.
- In the Mono listening mode, only the front speakers output sound if the Output Speaker setting is set to L/R (page 93).
- Check the Speaker Configuration (page 96).

Only the center speaker produces sound

- If you use the Dolby Pro Logic IIx Movie or Dolby Pro Logic IIx Music listening mode with a mono source, such as an AM radio station or mono TV program, the sound will be concentrated in the center speaker.
- In the Mono listening mode, only the front speakers output sound if the Output Speaker setting is set to C (page 93).
- Check the Speaker Configuration (page 96).

The surround speakers produce no sound

- When the Stereo or Mono listening mode is selected, the surround speakers produce no sound.
- Depending on the source and the current listening mode, not much sound may be produced by the surround speakers. Try another listening mode (page 82).
- Check the Speaker Configuration (page 96).

The center speaker produces no sound

- When the Stereo listening mode is selected, the center speaker produces no sound.
- In the Mono listening mode, only the front speakers output sound if the Output Speaker setting is set to L/R (page 93).
- Check the Speaker Configuration (page 96).

The surround back speakers produce no sound

- The surround back speakers are not used with all listening modes. Try another listening mode (page 82).
- Not much sound may be produced by the surround back speakers with some sources.
- Check the Speaker Configuration (page 96).
- While Powered Zone 2 is being used, playback in the main room is reduced to 5.1-channels and the surround back speakers produce no sound (page 111).

The subwoofer produces no sound

- If the source material contains no audio in the LFE channel, the subwoofer produces no sound.
- Check the Speaker Configuration (page 96).

The Zone 2/3 speakers produce no sound

- The Zone 2/3 speakers only output sources that are connected to an analog input. Check to see if the source component is connected to an analog input.

There's no sound with a certain signal format

- Check the digital audio output setting on the source component. On some game consoles, such as those that can play DVDs, the default setting is off.
- With some DVD-Video discs, you need to select an audio format from a menu or with the AUDIO button on your DVD player's remote controller.

Can't get 6.1- or 7.1-channel playback

- While Powered Zone 2 is being used, playback in the main room is reduced to 5.1-channels and the surround back speakers produce no sound (page 111).

The volume cannot be set to +18 dB (99)

- Check to see if a maximum volume has been set (page 106).
- After the Automatic Speaker Setup function has been run, or the volume level of each individual speaker has been adjusted (pages 79 and 100), the maximum volume may be reduced.

Noise can be heard

- Using cable ties to bundle audio cables with power cords, speaker cables, and so on can degrade audio performance, so don't use them.
- An audio cable may be picking up interference. Try repositioning your cables.

The Late Night function doesn't work

- Make sure that the source is Dolby Digital (page 91).

The analog multichannel input doesn't work

- Check the multichannel input connections (page 31).
- Make sure that the multichannel input is assigned to the input selector (page 52).
- Make sure that the multichannel input is selected (page 81).
- Check the audio output settings on your DVD player.

About DTS signals

- When playing DTS program material, using the pause, fast forward, or fast reverse function on your player may produce a short audible noise. This is not a malfunction.
- When DTS program material ends and the DTS bitstream stops, the AV receiver remains in DTS listening mode and the DTS indicator remains on. This is to prevent noise when you use the pause, fast forward, or fast reverse function on your player. If you switch your player from DTS to PCM, as the AV receiver does not switch formats immediately, you may not hear anything, in which case you should stop your player for about 3 seconds, and then resume playback.
- With some CD players, you won't be able to playback DTS material properly even though your player is con-

nected to a digital input on the AV receiver. This is usually because the DTS bitstream has been processed (e.g., output level, sampling rate, or frequency response changed) and the AV receiver doesn't recognize it as a genuine DTS signal. In such cases, you may hear noise.

The beginning of audio received by an HDMI IN can't be heard

- Since it takes longer to identify the format of an HDMI signal than it does for other digital audio signals, sound may not be output immediately.

Video

There's no picture

- Make sure that all video connecting plugs are pushed in all the way (page 26).
- Make sure that each video component is properly connected.
- On your TV, make sure that the video input to which the AV receiver is connected is selected.
- If your TV is connected to the HDMI OUT, set the HDMI Monitor setting to Yes (page 45), and select "--" in the "HDMI Input Setup" on page 46 to watch composite video, S-Video, and component video sources.
- If your TV is connected to the COMPONENT VIDEO MONITOR OUT 1 or COMPONENT VIDEO MONITOR OUT 2/ZONE 2 OUT, set the HDMI Monitor setting to No (page 45), and select "--" in the "Component Video Input Setup" on page 48 to watch composite video and S-Video sources.
- If the video source is connected to a component video input, your TV must be connected to the COMPONENT VIDEO MONITOR OUT 1 or COMPONENT VIDEO MONITOR OUT 2/ZONE 2 OUT or HDMI OUT (page 27).
- If the video source is connected to an HDMI input, your TV must be connected to the HDMI OUT (page 27).
- If the message "Resolution Error" appears on the AV receiver's display, this indicates that your TV does not support the current video resolution and you need to select another resolution on your DVD player.

The onscreen menus don't appear

- On your TV, make sure that the video input to which the AV receiver is connected is selected.

The picture is distorted

- On non-North American models, specify the TV system used in your area in the "TV Format Setup" on page 58.

Tuner

Reception is noisy, stereo FM reception suffers from hiss, or the FM STEREO indicator doesn't light up

- Relocate your antenna.
- Move the AV receiver away from your TV or computer.

- Listen to the station in mono (page 61).
- When listening to an AM station, operating the remote controller may cause noise.
- Passing cars and airplanes can cause interference.
- Concrete walls weaken radio signals.
- If nothing improves the reception, install an outdoor antenna.

Remote Controller

The remote controller doesn't work

- Make sure that the batteries are installed with the correct polarity (page 14).
- Make sure that the remote controller is not too far away from the AV receiver and there's no obstruction between the remote controller and the AV receiver's remote control sensor (page 14).
- Make sure you've selected the correct remote controller mode (page 15).
- Make sure you've entered the correct remote control code (page 119).

Can't control other components

- Make sure you've selected the correct remote controller mode (page 15).
- If you've connected an **RI**-capable Onkyo MD recorder, CD recorder, or RI Dock to the TAPE IN/OUT jacks, or an RI Dock to the GAME/TV IN jacks, for the remote controller to work properly, you must set the Input Display to MD, CDR, or DOCK, respectively (see page 49).
- The entered remote control code may not be correct. If more than one code is listed, try each one.
- If none of the codes work, use the Learning function to learn the commands of the other component's remote controller (page 122).
- With some AV components, certain buttons may not work as expected, and some may not work at all.
- To control an Integra/Onkyo component that's connected via **RI**, point the remote controller at the AV receiver. Be sure to enter the appropriate remote control code first (page 120).
- To control an Integra/Onkyo component that's not connected via **RI**, or another manufacturer's component, point the remote controller at that component. Be sure to enter the appropriate remote control code first (page 119).

Can't learn commands from another remote controller

- When learning commands, make sure that the transmitting ends of both remote controllers are pointing at each other.
- Are you trying to learn from a remote controller that cannot be used for learning? Some commands cannot be learned, especially those that contain several instructions.

Recording

Can't record

- On your recorder, make sure the correct input is selected.
- To prevent signal loops and damage to the AV receiver, input signals are not fed through to outputs with the same name (e.g., TAPE IN to TAPE OUT or VCR/DVR IN to VCR/DVR OUT).

Others

The sound changes when I connect my headphones

- When a pair of headphones is connected, the listening mode is set to Stereo, unless it's already set to Stereo, Mono, or Direct, in which case it stays the same.

How do I change the language of a multiplex source

- On the Audio Adjust menu, change the Multiplex setting to Main or Sub (page 94).

The **RI** functions don't work

- To use **RI**, you must make an **RI** connection and an analog audio connection (RCA) between the component and AV receiver, even if they are connected digitally (page 42).
- While Zone 2 or Zone 3 is selected, the **RI** functions don't work.

Components connected to the AV receiver's AC outlets don't turn on or off when the AV receiver is set to On or Standby

- When the HDMI Control setting is set to Enable (page 109), the AC outlets are on all the time regardless of whether the AV receiver is set to On or Standby, or Ready mode in this case, so any components connected to them cannot be turned on or off automatically.

The AV receiver contains a microcomputer for signal processing and control functions. In very rare situations, severe interference, noise from an external source, or static electricity may cause it to lockup. In the unlikely event that this happens, unplug the power cord from the wall outlet, wait at least 5 seconds, and then plug it back in again.

Onkyo is not responsible for damages (such as CD rental fees) due to unsuccessful recordings caused by this unit's malfunction. Before you record important data, make sure that the material will be recorded correctly.

Set the AV receiver to Standby before disconnecting the power cord from the wall outlet.

Specifications

Amplifier Section

Rated Output Power

North American:

130 watts minimum continuous power per channel, 8 ohm loads, 2 channels driven from 20 Hz to 20 kHz, with a maximum total harmonic distortion of 0.08% (FTC)

150 watts minimum continuous power per channel, 8 ohm loads, 2 channels driven at 1 kHz, with a maximum total harmonic distortion of 0.7% (FTC)

160 watts minimum continuous power per channel, 6 ohm loads, 2 channels driven at 1 kHz, with a maximum total harmonic distortion of 0.1% (FTC)

Australian:

7 ch × 180 W at 6 ohms, 1 kHz, 1 ch driven (IEC)

Maximum Output Power

Asian:

7 ch × 230 W at 6 ohms, 1 kHz, 1 ch driven (JEITA)

Dynamic Power	300 W (3Ω, Front) 250 W (4Ω, Front) 150 W (8Ω, Front)
THD (Total Harmonic Distortion)	0.05% (Power Rated)
Damping Factor	60 (Front, 1 kHz, 8Ω)
Input Sensitivity and Impedance	200 mV/ 47 kΩ (LINE) 2.5 mV/47 kΩ (PHONO MM)
Output Level and Impedance	200 mV/ 470 Ω (REC OUT)
Phono Overload	70 mV (MM 1 kHz, 0.5%)
Frequency Response	5 Hz–100 kHz/ +1 dB–3 dB (Direct mode)
Tone Control	±10 dB, 20 Hz (BASS) ±10 dB, 20 kHz (TREBLE)
Signal to Noise Ratio	110 dB (LINE, IHF-A) 80 dB (PHONO, IHF-A)
Speaker Impedance	4Ω–16Ω

Video Section

Input Sensitivity/Output Level and Impedance	1 V _{p-p} /75Ω (Component and S-Video Y) 0.7 V _{p-p} /75Ω (Component Pb/Cb,Pr/Cr) 0.28 V _{p-p} /75Ω (S-Video C) 1 V _{p-p} /75Ω (Composite)
Component Video Frequency Response	5 Hz – 100 MHz, –3 dB

Tuner Section

FM

Tuning Frequency Range

North American:	87.5 MHz– 107.9 MHz
Australian:	87.5 MHz– 108.0 MHz

AM

Tuning Frequency Range

North American:	530 kHz–1710 kHz
Australian:	522 kHz–1611 kHz

Digital Tuner

North American:	XM, SIRIUS
-----------------	------------

Preset Channel	40
----------------	----

General

Power Supply	AC 120 V, 60 Hz AC 220–240 V, 50/60 Hz
Power Consumption	
North American:	9.5 A
Australian:	870 W
Dimensions (W × H × D)	435 × 194 × 454.5 mm 17-1/8" × 7-5/8" × 17-7/8"
Weight	
North American:	23.1 kg 50.9 lbs.
Australian:	22.8 kg 50.3 lbs.

Video Input

HDMI	IN 1, IN 2, IN 3
Component	IN 1 (DVD), IN 2, IN 3
Composite	AUX 1, GAME/TV, CBL/SAT, VCR/DVR, DVD, AUX 2
S-Video	AUX 1, GAME/TV, CBL/SAT, VCR/DVR, DVD, AUX 2

Video Output

HDMI	OUT
Component	MONITOR OUT 1, MONITOR OUT 2
Composite	VCR/DVR OUT, MONITOR OUT
S-Video	VCR/DVR OUT, MONITOR OUT

Audio Inputs

Digital Inputs	COAXIAL (IN 1, IN 2, IN 3), OPTICAL (IN 1, IN 2), DIGITAL
Analog Inputs	PHONO, CD, TAPE, AUX 1, GAME/TV, CBL/SAT, VCR/DVR, DVD, MULTI CH (FRONT, CENTER, SUBWOOFER, SURR, SURR BACK), AUX 2
Multichannel Inputs	7.1 ch

Audio Outputs

Digital Output	OPTICAL (OUT)
Analog Outputs	TAPE, VCR/DVR, PRE OUT (FRONT, CENTER, SUBWOOFER, SURR, SURR BACK, ZONE 2, ZONE 3)
Multichannel Pre Outputs	7
Subwoofer Pre Outputs	1
Speaker Outputs	ZONE2 R, SURR BACK R, FRONT R, SURR R, CENTER, SURR L, FRONT L, SURR BACK L, ZONE2 L
Phones	PHONES

Control Terminal

MIC	Yes
RS232	1
Ethernet	1
IR Input/Output	2/1
12 V Trigger Out	3
USB	No

Specifications and features are subject to change without notice.

Integra Division of
ONKYO U.S.A. CORPORATION
18 park Way, Upper Saddle River, N.J. 07458, U.S.A.
Tel: 201-785-2600 Fax: 201-785-2650 <http://www.integrahometheater.com>

Integra Division of
ONKYO CORPORATION
Sales & Product Planning Div.: 2-1, Nisshin-cho, Neyagawa-shi, OSAKA 572-8540, JAPAN
Tel: 072-831-8023 Fax: 072-831-8124



I0805-2

SN 29344459A
(C) Copyright 2007 ONKYO CORPORATION Japan. All rights reserved.



* 2 9 3 4 4 4 5 9 A *